



Shaking up water



MACERATORS & PUMPS



TECHNICAL
BROCHURE

MADE IN FRANCE

Made in FRANCE

The SFA factory in Brégy, France has been in operation since 1958 and now has around 300 employees, all working hard to bring to life our SFA motto “Making things easier” for both our customers and installers.

Thanks to our continuous investment, our site has grown significantly and is now almost an autonomous production facility.



TEST AND DESIGN

New ideas and thorough testing take place in the site laboratory, to ensure the quality and longevity of each product.



WINDING AND MANUFACTURING MOTORS

SFA production lines have included the manufacture of the winding and assembly of the motors since 1960. This is a fully robotic process with digital controls to ensure the quality of the process throughout the production.

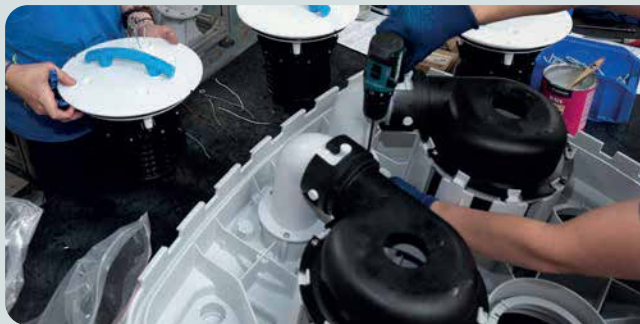

COMPONENT ASSEMBLY

Components are assembled by hand and by robots to ensure to ensure each component is meticulously positioned.



PRODUCING COMPOSITE AND RUBBER PARTS

We have 33 injection moulding machines and 760 moulds within the factory. The production is fully automated, from taking the plastic pellets from silos right through to finished goods.



ELECTRONIC COMPONENTS

Our electronic components are also manufactured on site at Brégy and assembled by our operators.



LOGISTICS

Our logistics platform dispatches SFA products to over 60 countries in the world.

Table of contents

MADE IN FRANCE	p. 02
ABOUT SFA AND ITS PRESENCE IN THE WORLD	p. 04
SFA SOLUTION	p. 05

SANIFLO



WHY SANIFLO ?	p. 06
Saniflo	p. 08
Sanitop	p. 09
Sanipro XR	p. 10
Saniaccess	p. 11
Sanipack	p. 12
Sanibest Pro	p. 13

GREY WATER PUMPS



WHY GREY WATER PUMPS ?	p. 14
Sanishower	p. 16
Sanivite	p. 17
Sanispeed	p. 18
Sanialarm	p. 19

LIFTING STATIONS



SELECT THE RIGHT LIFTING STATION	p. 20-21
HYDRAULICS	p. 22
WHICH LIFTING STATION TO INSTALL ?	p. 23
Sanicom 1	p. 24-25
Sanicom 2	p. 26-27
Sanicubic 1 WP	p. 28-29
Sanicubic 2 Classic	p. 30-31
Sanicubic 1 GR	p. 32-33
Sanicubic 2 GR	p. 34-35
Sanicubic 1 VX	p. 36-37
Sanicubic 2 VX	p. 38-39
Sanicubic 1 SC	p. 40-41
Sanicubic 2 SC	p. 42-43
Accessories and control boxes	p. 44-45

CONDENSATE PUMPS



WHY SANICLIM ? WHY SANICONDENS ?	p. 46
Sanicondens Clim Mini S	p. 48
Sanicondens Clim Pack S	p. 49
Sanicondens Clim Deco	p. 50
Sanicondens Pro	p. 51

SFA : LEADER AND SPECIALIST OF FLOOR STANDING PUMPS

For over 60 years, SFA Group has been helping to provide smart pumping solutions to our customers. Through our technological know-how we offer ingenious, reliable, easy to use and easy to install solutions, to have a bathroom or pantry wherever you need one.

OUR BRAND

In 1958 SFA group invented the macerator; an ingenious product that has revolutionised interior design throughout the world.

Our technological advances mean we have strived to improve our offer both to homes and commercial properties.

THE SFA GROUP IS FOCUSING ON 4 MAIN AREAS OF DEVELOPMENT:

- **Domestic pumping solutions**
- **Professional pumping solutions**
- **Equipment for the showering and spa industries**
- **Water treatment**

VISION AND PERSPECTIVE

Our growth in the sector was boosted by the acquisition of Zehnder Pumpen, who were already a global player in the lifting stations market.

Now SFA has an even stronger market position and even more pumps and lifting stations in our range to bring you the product that is right for your project.

AN INTERNATIONAL GROUP

SFA is established in 28 countries on 5 continents. In addition to providing products, SFA also trains professionals to help install and maintain our products to keep our customers happy.

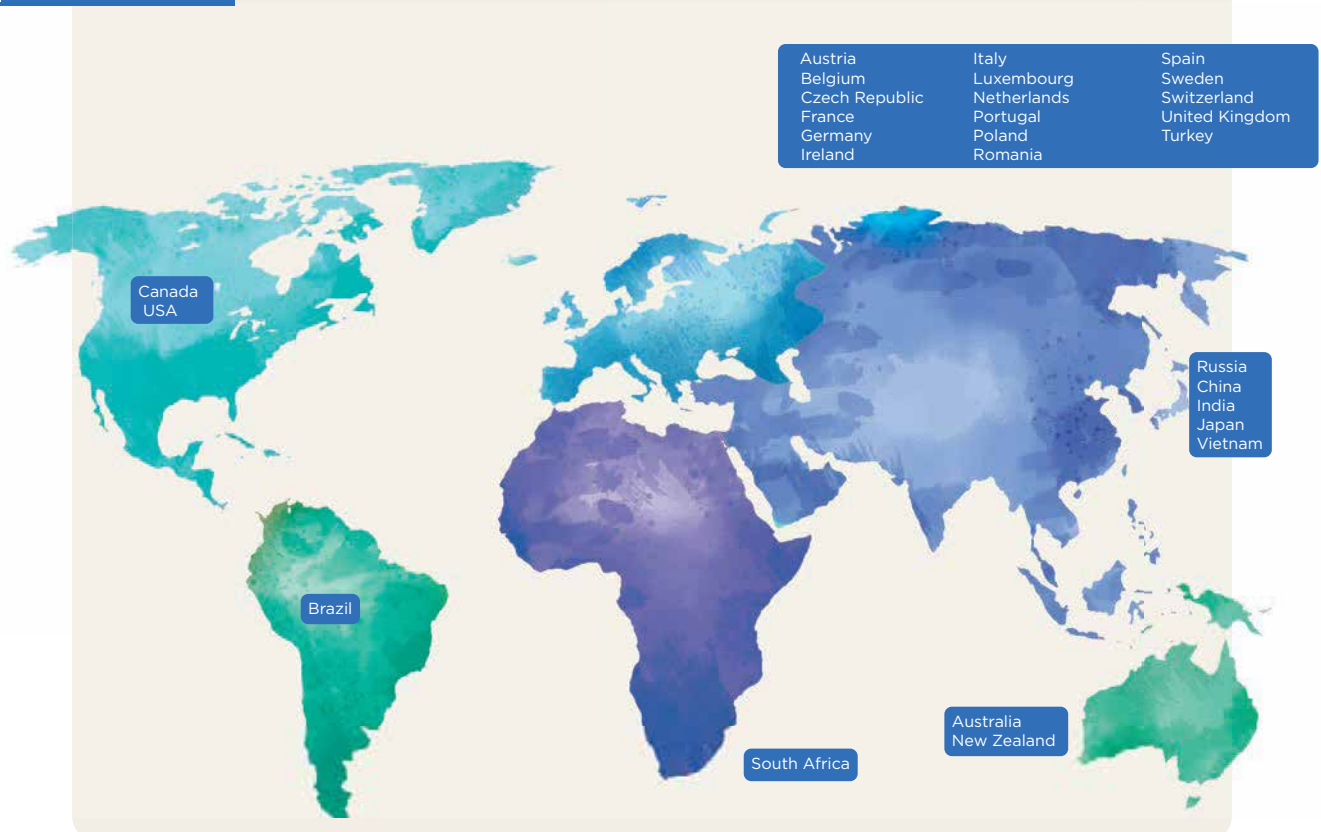

OUR MANY EXPORT COUNTRIES

Cyprus, Malta, Norway, Baltic States, Croatia, Israel, Ukraine, Bulgaria, Middle East, DOM-TOM, Algeria, Morocco, Tunisia, Egypt, Greece, Sudan, Finland, West Africa, ...

What is a SFA SOLUTION?

To adapt to the different stages of life, it may be necessary to modify and change your house by building an extension, or by adding an en-suite, additional bathroom or utility facilities. SFA products make it possible to carry out installation easily and without undertaking major building work.

If the additional new room is located at a distance from the main drainage system, perhaps in the attic, garage or in the basement, it is often easier and cost effective to use small bore pipework to create this new space rather than having to do major building work to connect to the main sewer.

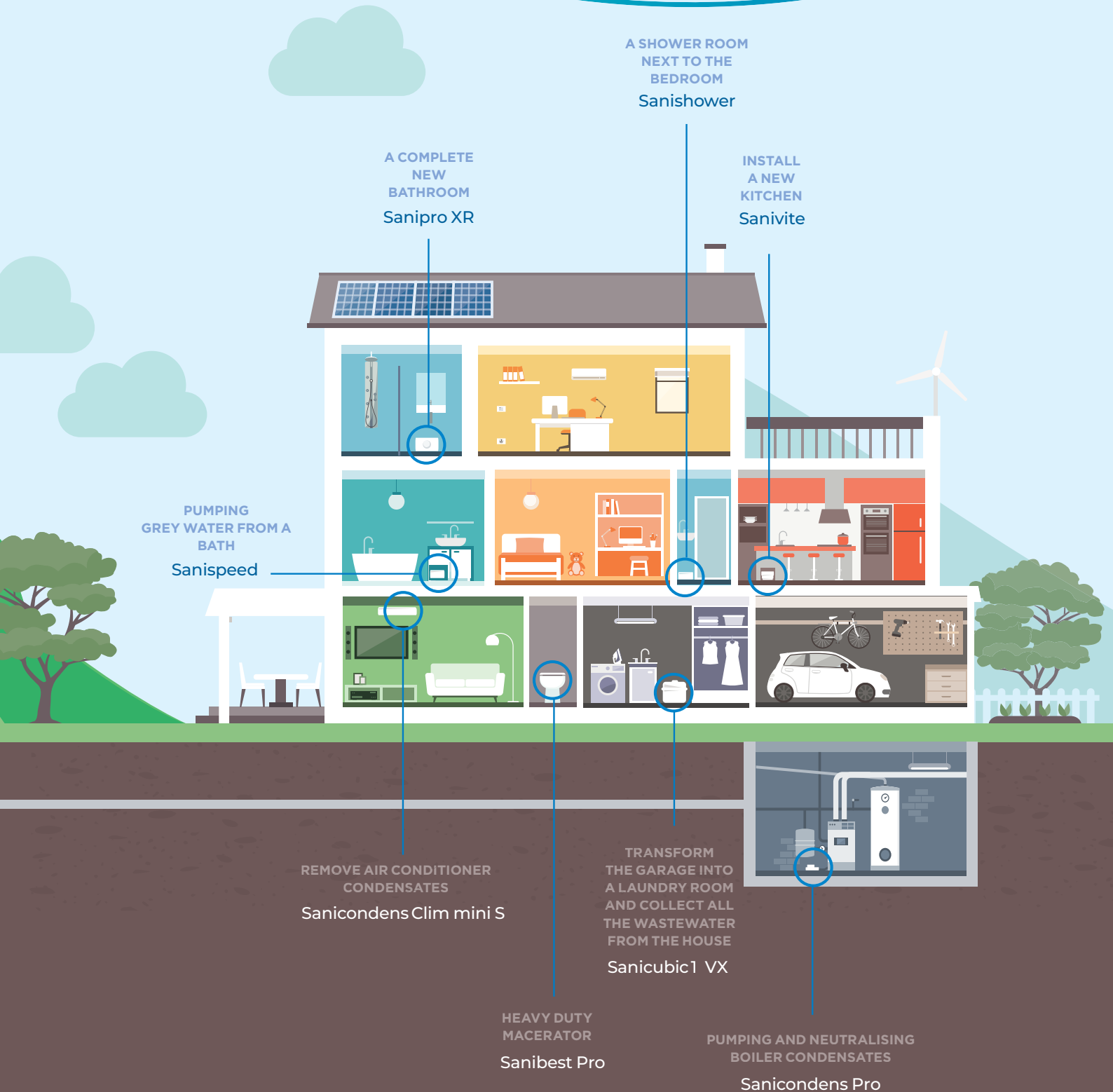



WHY SANIFLO?

The Saniflo range for creating washrooms anywhere and without major works.

For over 60 years, SFA has offered wastewater pumping solutions to facilitate property development.

Installing a Saniflo lets you create sanitary fixtures anywhere in the house, even without gravity drainage!

A water supply, a small diameter discharge pipe and an electrical socket are all you need to install an SFA macerator.

BEFORE



AFTER



Saniflo®

	 Toilet	 Wall-hung toilet	 Wash basin	 Bidet	 Shower cubicle	 Collectivity	 Easy operation
 <p>Saniflo Perfect for toilet drainage</p> <p>p.8 •</p>							✓
 <p>Sanitop Drains both the toilet and washbasin</p> <p>p.9 •</p>			•				✓
 <p>Sanipro XR Drains all the water from a bathroom</p> <p>p.10 •</p>			•	•	•		✓
 <p>Saniaccess 1-2-3 Complete solutions perfect for rental accommodation</p> <p>p.11 •</p>			•	•	•		✓
 <p>Sanibest Pro Heavy duty macerator pump</p> <p>p.13 •</p>			•	•	•	•	✓
 <p>Sanipack The macerator for wall hung WC</p> <p>p.12 •</p>		•	•	•	•		✓

- RELIABILITY AND INNOVATION SINCE 1958
- EASY MAINTENANCE THANKS TO DIFFERENT ACCESS POINTS
- SLEEK DESIGN
- THE QUIETEST RANGE ON THE MARKET

Saniflo



The original macerator pump unit that allows installation of an extra WC when a conventional solution isn't possible.



4 m
100 m



BY Cert. 6043364



PRODUCT BENEFITS

- Perfect for draining wastewater from a toilet.
- Suitable for use in a basement or loft conversion.
- Quiet product.

CONNECTIONS

← Discharge diameter ext. : 22/28/32 mm

→ External inlet diameter : 100 mm



Single blade cutter



PACKAGING

Saniflo, non-return valve, connectors, activated carbon filter to neutralise odours

CURVE

Discharge height (m)

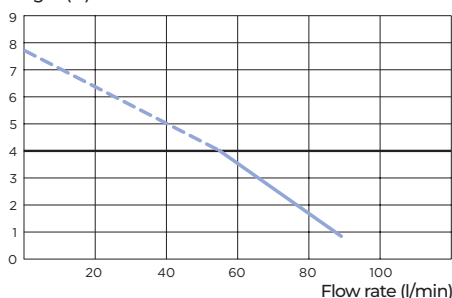

TECHNICAL FEATURES

Number of entries	1
External inlet diameter	100 mm
Discharge diameter ext.	22/28/32 mm
Max. incoming temperature	35 °C
Voltage - Frequency	220-240 V - 50-60 Hz
Motor power	400 W
IP Rating	IP44
Electrical class	I
Identification and logistics	
Gross weight	5.6 kg
Factory code	SXSTD

OPTIONAL

Sanialarm
Factory code : ALARM
See pg. 19



DIMENSIONS

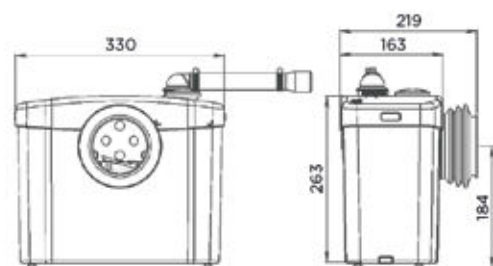

Dimensions (mm)

Sanitop



Similar to the original Saniflo but allows the connection of a WC and a wash basin.



5 m
100 m



BY Cert. 6045364



PRODUCT BENEFITS

- Lets you install 1 toilet + 1 washbasin.
- Quiet product.

CONNECTIONS

← Discharge diameter ext. :
22/28/32 mm

→ External inlet diameter :
40, 100 mm



Single blade cutter



PACKAGING

Sanitop, non-return valve, connectors and activated carbon filter included to neutralise odours.

CURVE

Discharge height (m)

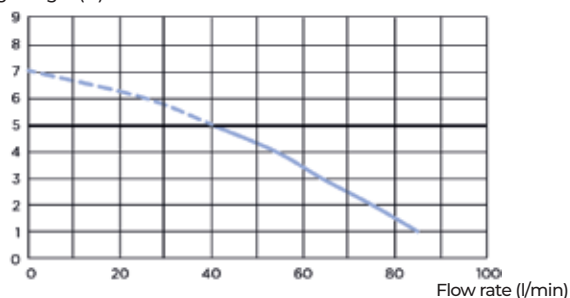

TECHNICAL FEATURES

Number of entries	2
External inlet diameter	40, 100 mm
Discharge diameter ext.	22/28/32 mm
Max. incoming temperature	35 °C
Voltage - Frequency	220-240 V - 50-60 Hz
Motor power	400 W
IP Rating	IP44
Electrical class	I
Identification and logistics	
Gross weight	5.7 kg
Factory code	ST2STD

OPTIONAL

Sanialarm
Factory code : ALARM
See pg. 19



DIMENSIONS

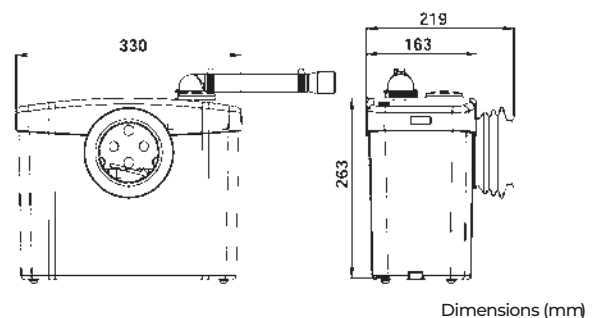

Sanipro XR



The neat unit makes it easy to install an extra bathroom. Can easily deal with a WC, basin, bidet and a power shower.



5 m
100 m



BV Cert. 6045364



PRODUCT BENEFITS

- Reliable and efficient macerating system.
- Drains all the water from a bathroom room.
- Quiet product.

CONNECTIONS

← Discharge diameter ext. : 22/28/32 mm

→ External inlet diameter : 40,100 mm



Single blade cutter

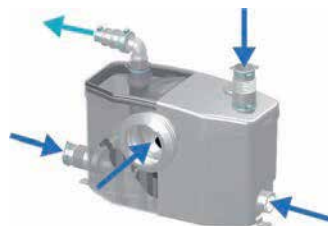

PACKAGING

Sanipro XR, non-return valve, connectors and activated carbon filter included to neutralise odours.

CURVE

Discharge height (m)

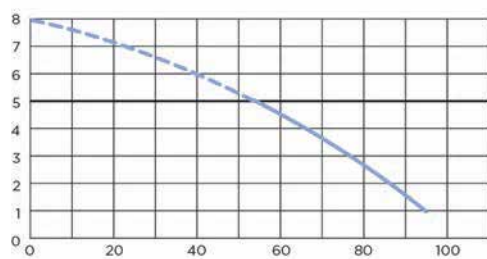

Flow rate (l/min)

TECHNICAL FEATURES

Number of entries	4
External inlet diameter	40, 100 mm
Discharge diameter ext.	22/28/32 mm
Min. shower tray height	13 cm
Max. incoming temperature	35 °C
Voltage - Frequency	220-240 V - 50-60 Hz
Motor power	400 W
IP Rating	IP44
Electrical class	I
Identification and logistics	
Gross weight	7 kg
Factory code	SRSTD

OPTIONAL

Sanialarm
Factory code : ALARM
See pg. 19



DIMENSIONS

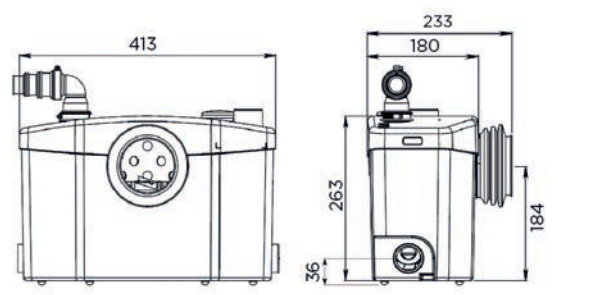

Dimensions (mm)

Saniaccess 1-2-3

Macerators equipped with top access traps for easy servicing



Saniaccess 3
Saniaccess 2
Saniaccess 1



5 m
100 m



BV Cert. 0045304



PRODUCT BENEFITS

- 3 models for all needs - WC only or for a complete bathroom.
- Easy maintenance with double access to the product.
- Ideal for rental properties.

CONNECTIONS

← Discharge diameter ext. : 22/28/32 mm

→ External inlet diameter : 40,100 mm

• Direct access to the basket in case of blockage due to improper use of the device without dismantling the device and emptying the tank.



Single blade cutter



PACKAGING

Saniaccess, non-return valve, connectors, activated carbon filter included to neutralise odours

CURVE

Discharge height (m)

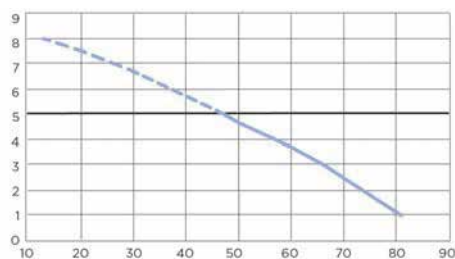

Flow rate (l/min)

TECHNICAL FEATURES

	1	2	4
Number of entries	1	2	4
External inlet diameter	40,100 mm		
Discharge diameter ext.	22/28/32 mm		
Min. shower tray height	15 cm		
Max. incoming temperature	35 °C		
Frequency Voltage	220-240 V - 50-60 Hz		
Motor power	400 W		
IP rating	IP44		
Electrical class	I		
Noise level	46 dB(A)		
Identification and logistics			
Gross weight	7 kg		
Factory code	SANIACCESS1	SANIACCESS2	SANIACCESS3

DIMENSIONS

Saniaccess*1-2

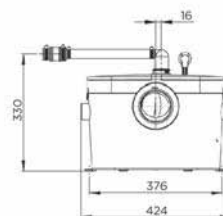

Saniaccess*3

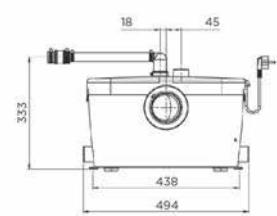

Dimensions (mm)

Sanipack



Designed for a back-to-wall-hung sanitaryware and a complete modern and sleek finish bathroom room.



5 m
100 m



IBV Cert. 6045369



PRODUCT BENEFITS

- The macerator for wall-hung bowls that fits in partitions.
- Ideally suited for fitted bathrooms.
- Compact design, suitable for discreet installation behind a partition.
- Extra slim dimensions.

CONNECTIONS

← Discharge diameter ext. :
22/28/32 mm

→ External inlet diameter :
40, 100 mm



Single blade cutter



TECHNICAL FEATURES

Number of entries	4
External inlet diameter	40, 100 mm
Discharge diameter ext.	22/28/32 mm
Min. shower tray height	13 cm
Max. incoming temperature	35 °C
Voltage - Frequency	220-240 V - 50-60 Hz
Motor power	400 W
IP Rating	IP44
Electrical class	I
Identification and logistics	
Gross weight	5.5 kg
Factory code	PA2STD

PACKAGING

Sanipack, non-return valve, connectors, activated carbon filter to neutralise odours

CURVE

Discharge height (m)

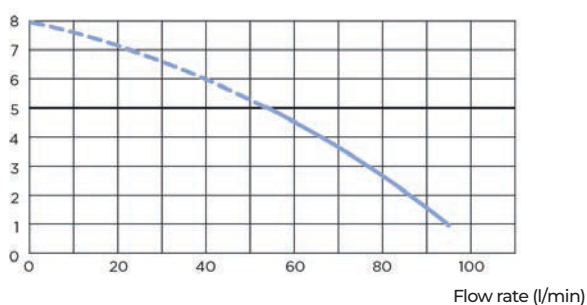

DIMENSIONS

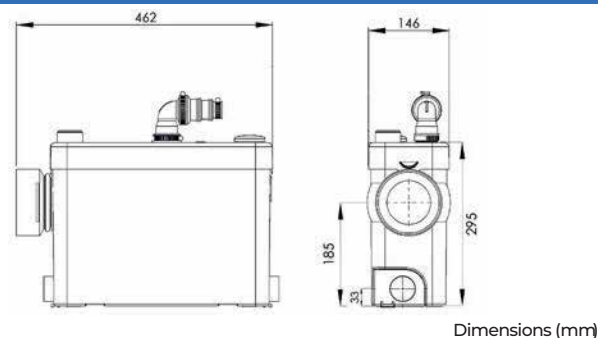

Sanibest Pro



Heavy duty macerator pump suitable for commercial applications.



7 m
110 m



BY Cert 0015364



PRODUCT BENEFITS

- Suitable for intensive use in commercial environments.
- Direct access to electronic components.

CONNECTIONS

← Discharge diameter ext.: 22/28/32 mm

Access directly to the electrics via the lid

→ External inlet diameter: 40, 100 mm



Pro X K2 grinder



PACKAGING

Sanibest Pro, non-return valve, connectors, activated carbon filter included to neutralise odours

CURVE

Discharge height (m)

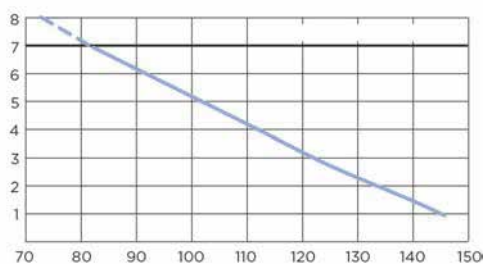

Flow rate (l/min)

TECHNICAL FEATURES

Number of entries	4
External inlet diameter	40, 100 mm
Discharge diameter ext.	22/28/32 mm
Min. shower tray height	15 cm
Max. incoming temperature	35 °C
Voltage - Frequency	220-240 V - 50-60 Hz
Motor power	1100 W
IP Rating	IP44
Electrical class	I
Identification and logistics	
Gross weight	12 kg
Factory code	B3PRO

OPTIONAL

Sanialarm
Factory code : ALARM
See pg. 19



DIMENSIONS

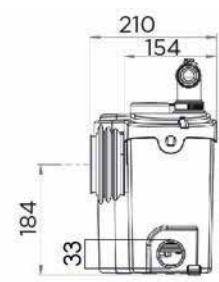
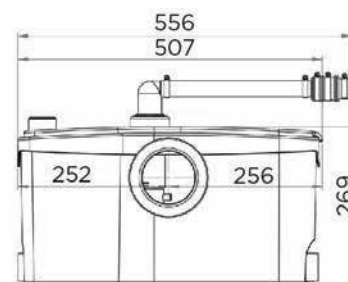

Dimensions (mm)

WHY GREY WATER PUMP?

SFA designs grey water pumps that are easy to install, with no major works needed. Among these the domestic pumps range is ideal for creating a new bathroom, kitchen, or laundry room.

SFA pumps help you to create a new bathroom, kitchen or laundry room wherever you want in the house, even in the absence of gravity drainage.

Easy to install, these small size pumps can be placed inside a cabinet or under the sink. An ideal solution for creating an additional shower room in your house or a pantry at your office. What's more, this investment also increases the property's value (by 10% on average).

BEFORE



AFTER



Grey water pumps

	 Walk-in shower	 Shower tray	 Tiled shower tray	 Shower cubicle	 Bidet	 Wash basin	 Bath	 Washing machine	 Dish washer	 Sink
 <p>Sanishower Pump suitable for standard shower tray</p> <p>p.16</p>			•	•	•					
 <p>Sanivite Pump suitable for installing a pantry</p> <p>p.17</p>				•	•	•	•	•	•	•
 <p>Sanispeed Pump suitable for installing a laundry room or a kitchen</p> <p>p.18</p>				•	•	•	•	•	•	•

- MULTIPLE FITTING OPTIONS: EASY TO INSTALL AND COMPACT
- A BATHROOM, A LAUNDRY ROOM OR A KITCHEN WHEREVER YOU WANT WITHOUT MAJOR WORK!

Sanishower



A compact pump designed to be installed next to or underneath a shower tray with access for maintenance.



4 m
40 m



IBV Cert. 6045364



PRODUCT BENEFITS

- Pump suitable for standard shower tray.
- Low noise level.
- Aesthetic design for discreet installation.
- Low starting level.

CONNECTIONS

← Discharge diameter ext. : 32 mm

→ External inlet diameter : 32, 40 mm



TECHNICAL FEATURES

Number of entries	2
External inlet diameter	32, 40 mm
Discharge diameter ext.	32 mm
Min. shower tray height	12 cm
Max. incoming temperature	35 °C
Voltage - Frequency	220-240 V - 50-60 Hz
Motor power	250 W
IP Rating	IP44
Electrical class	I
Identification and logistics	
Gross weight	4.6 kg
Factory code	D2STD

PACKAGING

Sanishower, non-return valve, connectors

CURVE

Discharge height (m)

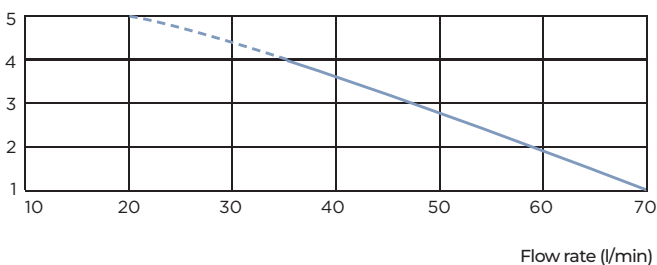

DIMENSIONS

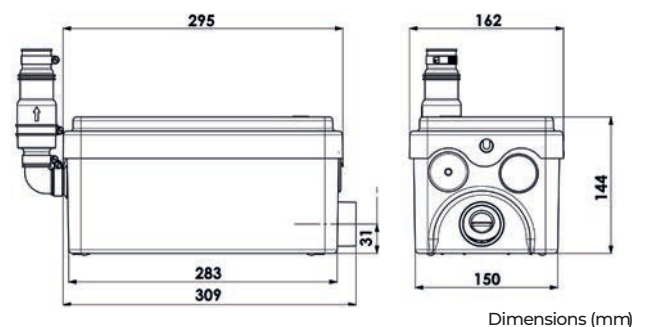

Sanivite



Ideally suited for a kitchen or a pantry with four inlets.



5 m
50 m



BYCref: 0053364



PRODUCT BENEFITS

- Ideally suited for a kitchen or pantry.
- Low level switch-on.
- Carbon filter included.
- 4 inlets available.

CONNECTIONS

← Discharge diameter ext.: 32 mm

→ External inlet diameter: 40 mm



PACKAGING

Sanivite, non-return valve, connectors, activated carbon filter included to neutralise odours

CURVE

Discharge height (m)

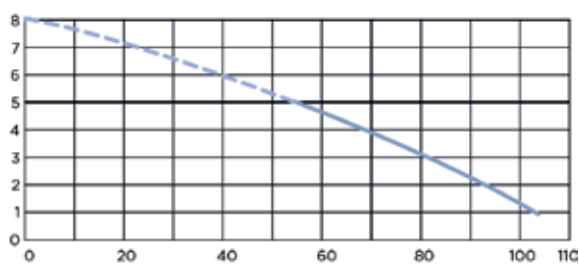

Flow rate (l/min)

TECHNICAL FEATURES

Number of entries	4
External inlet diameter	40 mm
Discharge diameter ext.	32 mm
Min. shower tray height	15 cm
Max. incoming temperature	60°C intermittently (max. 5 min)
Voltage - Frequency	220-240 V - 50-60 Hz
Motor power	400 W
IP Rating	IP44
Electrical class	I
Identification and logistics	
Gross weight	6.2 kg
Factory code	SVSTD

OPTIONAL

Sanialarm
Factory code : ALARM
See pg. 19



DIMENSIONS

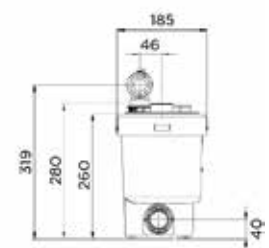
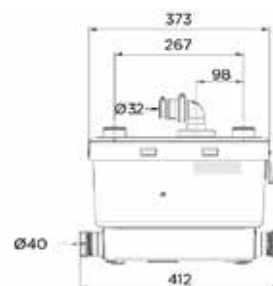

Dimensions (mm)

Sanispeed



Ideal for light commercial environments such as small shops, cafes, offices, bars and dental surgeries.



7 m
70 m



PRODUCT BENEFITS

- Ideal for installing a professional kitchen.
- Water softener compatible.
- Flow rate: 110 L/min.
- Can accept 75°C water.
- 4 inlets.

CONNECTIONS

- ← Discharge diameter ext. : 32 mm
- External inlet diameter : 40 mm



PACKAGING

Sanispeed, non-return valve, connectors. activated carbon filter to neutralise odours

CURVE

Discharge height (m)

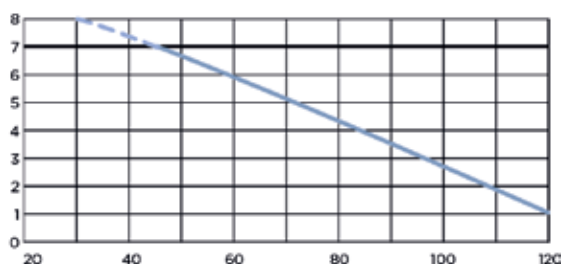

Flow rate (l/min)

TECHNICAL FEATURES

Number of entries	4
External inlet diameter	40 mm
Discharge diameter ext.	32 mm
Min. shower tray height	15 cm
Max. incoming temperature	75°C intermittently (max. 5 min)
Voltage - Frequency	220-240 V - 50-60 Hz
Motor power	400 W
IP Rating	IP44
Electrical class	I
Identification and logistics	
Gross weight	7 kg
Factory code	SSPSTD

OPTIONAL

Sanialarm
Factory code : ALARM
See pg. 19



DIMENSIONS

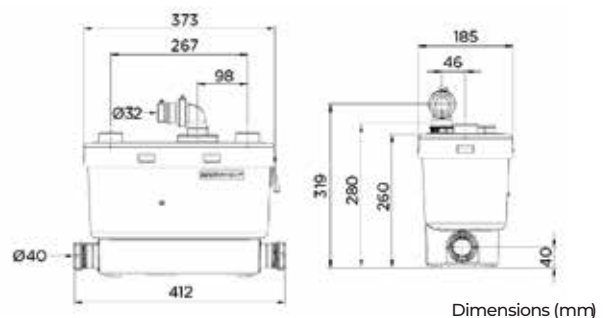

Sanialarm

A unique concept

Occasional power outages, scaling of poorly maintained old appliances or even problems with clogged pipes, are all factors in significant variation of the water level permanently contained in an SFA macerator or pump.

To tackle this kind of unpredictability, SFA offers an efficient solution that provides instant alerts to avoid inappropriate use and take immediate action.

Reference
ALARM



Can be installed on all macerator pumps
and also Sanivite and Sanispeed
The Sanialarm works with 2.1.5V batteries
(not supplied)

How does it work?

The Sanialarm is positioned on the cover of the SFA device. It consists of a level pressure switch which automatically activates the warning buzzer when the water volume exceeds the maximum permitted level. The alarm then produces an intermittent sound until it is silenced, and the problem resolved.

Easily install the Sanialarm



1
Insert 2 standard 1.5V batteries
(not supplied) into the unit.



2
Drill a 10 mm diameter hole
in the location shown on the
appliance hood.



3
Coat with silicone grease before
inserting the pressure switch
tube of the Sanialarm.



4
Attach the Sanialarm
inside the opening of the tube.



5
Switch to the
ON position.

**BEFORE HANDLING:
DISCONNECT
THE POWER SUPPLY
FROM THE
MACERATOR.**

1 DETERMINE THE PEAK FLOW

This is the amount of water to be drained according to the type and number of sanitary fixtures connected to the pumping station.

The flow measures a volume per unit of time. It is expressed in cubic metres per hour (m³/hr) or litres per second (L/s).

ESTIMATED FLOW



On the basis of 1 residence comprising: 1 toilet, 1 bath, 1 shower, 1 washbasin, 1 sink, 1 washing machine, 1 dishwasher

Number of residences	Flow
1 residence (1 to 3 inhabitants)	2.5 m ³ /hr
Up to 2 residences (4 to 6 inhabitants)	5 m ³ /hr
Up to 4 residences (7 to 9 inhabitants)	10 m ³ /hr
Up to 6 residences (10 to 12 inhabitants)	15 m ³ /hr

2 CALCULATING THE TOTAL DYNAMIC HEAD (TDH)

TDH IS THE PRESSURE THAT THE PUMP MUST PROVIDE BETWEEN THE SUCTION POINT AND THE DISCHARGE POINT.

$$TDH = GEO H + H v$$

Geo H = Geometric height

This is the height of the discharge in metres.

H v = Total discharge losses in the discharge pipe (expressed in metres of water column).

There are 2 types of friction loss:

- regular (or linear) friction loss: these result from the friction of the fluid against the walls of the discharge pipe
- the singular discharge losses by friction: they come from accidents related to pipes (elbow, non-return valves, etc.)

These have to be added to the geometric height to determine the total dynamic head.

The value obtained in this table must be multiplied by the total length of the drainage pipe to obtain the total loss of loads.

TABLE OF DISCHARGE LOSSES

Flow in m ³ /hr	PN10 pressure PVC piping					
	DN 32 36.2/40	DN 40 45.2/50	DN 50 57/63	DN 65 67.8/75	DN 80 81.4/90	DN 100 101.6/110
2	0.011					
3	0.022	0.008				
4	0.037	0.013				
5	0.054	0.019	0.006			
6	0.075	0.026	0.009			
7	0.099	0.034	0.011			
8	0.126	0.043	0.014	0.006		
9		0.054	0.018	0.008		
10		0.065	0.021	0.009		
12		0.090	0.029	0.013	0.005	
15			0.044	0.019	0.008	
20				0.032	0.013	0.005
25				0.048	0.020	0.007
30					0.028	0.010
40						0.016
50						0.024
60						0.033
70						0.044
80						0.056



HELP WITH CHOOSING THE LIFTING STATIONS

CASE STUDY

Once the total dynamic head and the peak flow have been determined, the pump's typical curve can determine its suitability for requirements.

The volume of the tank will then be determined in accordance with the specific constraints of each installation.

2 residences are connected to one lifting station. The station must discharge wastewater at a height of 4 m over a total pipe length of 10 m with a PVC 50 mm exterior.

- **Geometric height:** 4 m.
- **Table of discharge losses:** for 2 residences, we estimate the flow at peak times to be 5 m³/hr.

According to the discharge losses table, the height is: $0.019 \times 10 = 0.19$ m

→ **Therefore, the total dynamic head will be: 4 m + 0.19 m = 4.19 m**

→ The project therefore presents the following criteria:
TDH = 4.19 m and Flow = 5 m³/hr

- **Our client wants to install a floor-mounted pumping station in his basement.**

The Sanicubic range corresponds to his needs.

Analysis of the pump performance curve for the Sanicubic confirms to us that the Sanicubic 2 Classic station meets the needs of the installation.



MULTI-CHANNEL WHEEL
Sanicom 1
Sanicom 2



GRINDER WHEEL PRO X K2
Sanicubic 1/1 WP
Sanicubic 2 Classic
Sanicubic 2 Pro/2 Pro Smart



GRINDER WHEEL PRO X K3
Sanicubic 1 GR
Sanicubic 2 GR



KX V6 VORTEX WHEEL
Sanicubic 1 VX
Sanicubic 2 VX



SINGLE-CHANNEL WHEEL
Sanicubic 1 SC
Sanicubic 2 SC

HYDRAULICS

.....

The pump is the main element of the lifting station. It is expected to reliably pump away wastewater from an installation.

SFA is always innovating to continuously improve the performance of their pumps.

Their reliability and safety are guaranteed thanks to the multitude of tests carried out in our factories during the design process: two 100% electrical tests, a 100% leakage test and a functional test.

Floor-standing lifting stations

























WHY SANICUBIC?

Since it is not always possible to install an underground lifting station, SFA offers the Sanicom and Sanicubic range!

These are pumping stations that can simply be placed on the ground for easy installation and maintenance.

Sanicom is for pumping grey water, while Sanicubic pumps both grey water and black water.

		 Individual	 Commercial	 Collective	Examples of use
	Sanicom® 1 Grey water	 ✓	✓		<ul style="list-style-type: none"> • Bakeries, laboratories, juice bars: pumping for sinks, bars, dishwashers, glass washers • Hair salons: pumping for hair disposal trays in hair salons • Gymnasiums, restaurants, dental and veterinary practices: water pumping from sanitary facilities with sinks, showers and urinals • Bread oven: high temperature condensates drainage • Boiler room and softeners: grey water drainage • Production water drainage
	Sanicom® 2 Grey water	 ✓	✓		
	Sanicubic 1 WP Wastewater	 ✓			<ul style="list-style-type: none"> • Entire detached house: wastewater drainage • House extension or pool house design: wastewater drainage • Individual houses or villas • Factory extension (design of sanitary fittings, toilet, sinks and urinals): wastewater drainage • Converted containers, porta cabins, camp sites: wastewater drainage • River developments, floating chalets, barges, boat houses: wastewater drainage
	Sanicubic 2 Classic Wastewater	 ✓	✓		
	Sanicubic 1 GR Wastewater	 ✓	✓		
	Sanicubic 2 GR Wastewater	 ✓	✓		
	Sanicubic 1 VX Wastewater	 ✓	✓		<ul style="list-style-type: none"> • Apartments: pumping starting from 2 apartments • Bars and restaurants: wastewater drainage • Stadiums: wastewater drainage • Hotels, camp sites, offices: wastewater drainage • Boats: wastewater drainage
	Sanicubic 2 VX Wastewater	 ✓	✓	✓	
	Sanicubic 1 SC Wastewater	 ✓	✓	✓	
	Sanicubic 2 SC Wastewater	 ✓	✓	✓	

- **HIGH PERFORMANCE OPERATION WITH THE SFA GRINDER** (EXCEPT SANICUBIC 1 VX, SANICUBIC 2 VX AND SANICOM)
- **EASILY REMOVABLE PUMP(S) AND LEVEL SENSOR(S)**
- **CONTROL UNIT SUPPLIED AS STANDARD** (EXCEPT SANICUBIC 1 AND SANICOM 1)
- **SECURE OPERATION WITH THE AUDIBLE AND VISUAL ALARM BOX**
- **LOW INLETS**

Sanicom 1

Grey water

The Sanicom 1 station is designed to lift water from commercial environments such as doctor clinics, showers in sports halls, launderettes, pubs, hair salons etc. It can take water up to 90 °C for short periods of time. The station is equipped with a pressure switch system that turns on and off the pump. A high level alarm is built into the unit. A remote audible and visual alarm is available as an option.



PERFORMANCES

- Total dynamic head: 11 m
- Max. flow rate : 12 m³/h

PRODUCT BENEFITS

- Ability to pump grey water (except toilets) up to 90°C.
- Simple and easy installation without digging soil disbursement.
- Inlets on each side of the device for greater flexibility (ext. diameter 40).
- Removable motor and level sensors for ease of maintenance.



BV Cert. 6045364



OPTIONAL

Wired alarm box Sanicom 1



CONNECTIONS

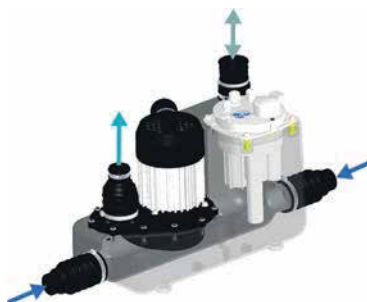

➡ External inlet diameter : 40, 50 mm

➡ Discharge diameter ext. : 32 mm

↔ Ext. ventilation diameter : 50 mm



Multi-channel

DIMENSIONS

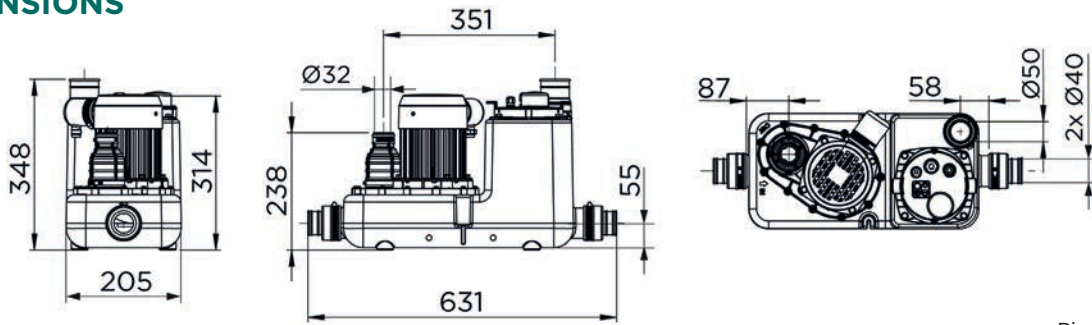

Dimensions (mm)

CURVE

Discharge height (m)



Flow rate (m³/h)

Sanicom 1 v02

Type of control box	Integrated
Material	
Tank	PE
Pump housing	PA 12 GF
Motor housing	Aluminium
Impeller	PA 6 GF
Technical features	
Voltage (V)	230
Frequency (Hz)	50-60
Power consumption P1 (W)	750
Power output P2 (W)	525
IP Rating	IPX4
Hydraulics	
Total dynamic head (m)	11
Max. flow rate (m ³ /h)	12
External inlet diameter (mm)	40, 50
Discharge diameter ext. (mm)	32
Ext. ventilation diameter (mm)	50
Total volume (L)	14
Useable volume (L)	5.7
ON Level / OFF level (mm)	135/50
Alarm level (mm)	205
Particle size (mm)	8
Max. temperature of the pumped liquid (5 min)	90 °C
Type of impeller	Multi-channel
Type of activation	Pneumatic
Identification and logistics	
Gross weight (kg)	11.5
Factory code	COM1002

Sanicom 2

Grey water

Sanicom 2 is a two-pump lifting station designed for commercial use. It removes grey water up to 90 °C (max 5 mins) from restaurant kitchens, laundries, doctors' surgeries, pubs, hair salons etc. Sanicom 2 consists of 2 independent pumps. The second pump assists the first in case of a sudden large water supply. The tank is equipped with 2 immersion tubes controlling the motor on the one hand and the alarm system on the other. A remote wired alarm is available as an option.



PERFORMANCES

- Total dynamic head : 15 m
- Max. flow rate : 16 m³/h

PRODUCT BENEFITS

- Ability to pump grey water up to 90 °C.
- Easy installation without soil disbursement.
- 2 low side inlets Ø ext. 80 (connections possible in Ø ext. 50 or Ø ext. 40).
- Supplied with remote control unit: 2 alternating pumps for more intensive use.
- Removable motors and level sensors for ease of maintenance.



BV Cert. 6045364



DELIVERED AS STANDARD

Classic control Box



OPTIONAL

Wired alarm box Sanicom 2



CONNECTIONS



➡ External inlet diameter : 40, 50, 80 mm

➡ Discharge diameter ext. : 50 mm

↔ Ext. ventilation diameter : 50 mm



Multi-channel

DIMENSIONS

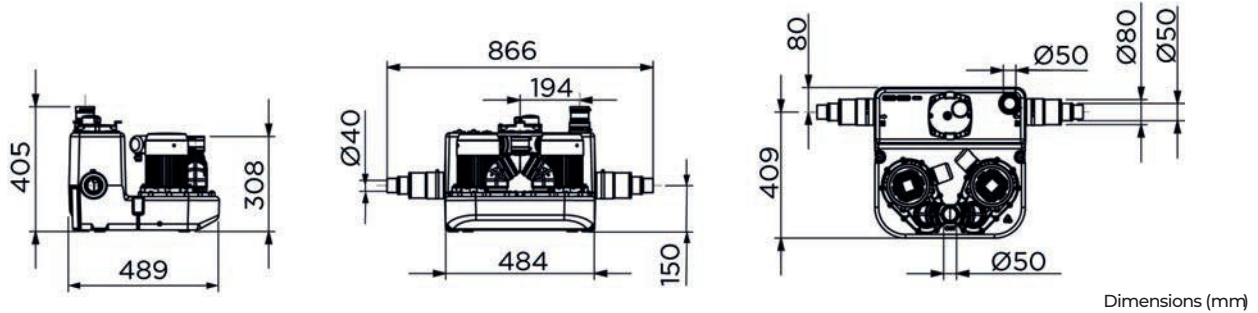

CURVE

Discharge height (m)

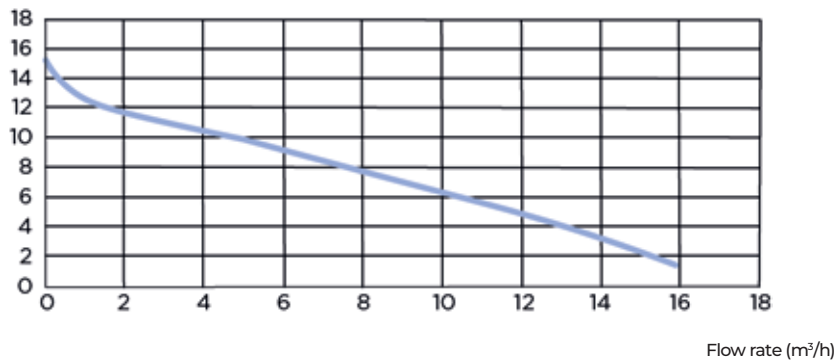

Flow rate (m³/h)

Sanicom 2 v02

Type of control box	Classic control Box
Material	
Tank	PE
Pump housing	PA 12 GF
Motor housing	Aluminium
Impeller	PA 6 GF
Technical features	
Voltage (V)	230
Frequency (Hz)	50-60
Power consumption P1 (W)	1500
Power output P2 (W)	1050
IP Rating	IPX4
Hydraulics	
Total dynamic head (m)	15
Max. flow rate (m ³ /h)	16
External inlet diameter (mm)	40, 50, 80
Discharge diameter ext. (mm)	50
Ext. ventilation diameter (mm)	50
Total volume (L)	34
Useable volume (L)	13
ON Level /OFF level (mm)	145/60
Alarm level (mm)	215
Particle size (mm)	8
Max. temperature of the pumped liquid (5 min)	90 °C
Type of impeller	Multi-channel
Type of activation	Pneumatic
Identification and logistics	
Gross weight (kg)	25
Factory code	COM2002

Sanicubic 1 WP

Grey water, black water

Sanicubic 1 WP lifting station is designed for individual use (house, small commercial premises) and collects all waste water from toilets, bathrooms, kitchens or laundry rooms. The unit benefits from the Pro X K2 grinding technology removing waste water through small 50 mm diameter ext. pipe.



PERFORMANCES

- Total dynamic head : 13 m
- Max. flow rate : 15 m³/h

PRODUCT BENEFITS

- Simple and easy installation.
- 4 inlets, 2 of which are low for greater installation flexibility.
- ProX K2 grinding technology lifts wastewater through a 50 mm ext. diameter hose.
- IP68 reinforced seals and remote control.
- Removable motor and level sensors for ease of maintenance.



BV Cert. 6045366



DELIVERED AS STANDARD

Classic control Box



Remote wired audible and visual alarm unit (5m)



CONNECTIONS



External inlet diameter : 40, 50, 100, 110 mm

Discharge diameter ext. : 50 mm

Ext. ventilation diameter : 50 mm



Pro X K2 grinder

DIMENSIONS

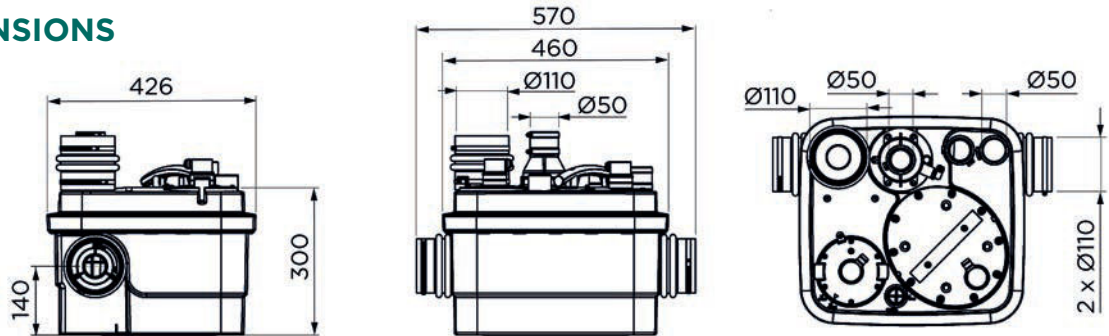

Dimensions (mm)

CURVE

Discharge height (m)

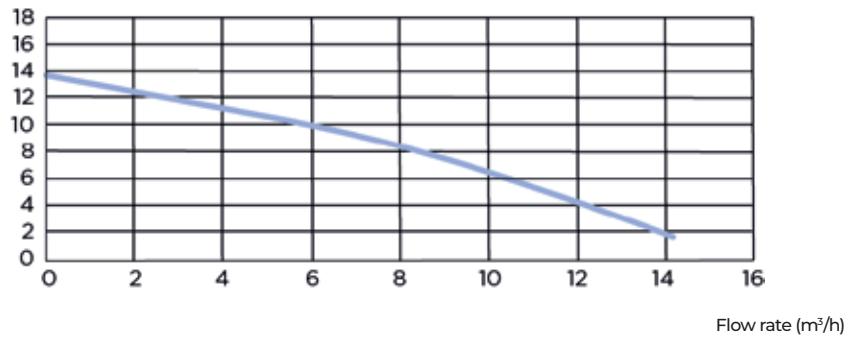

Flow rate (m³/h)

Sanicubic 1 WP

Type of control box	Classic
Material	
Tank	PP
Pump housing	PA 12 GF
Motor housing	PA 12 GF
Impeller	PP GF
Technical features	
Voltage (V)	230
Frequency (Hz)	50-60
Power consumption P1 (W)	1500
Power output P2 (W)	1050
Mode of operation	S3 30%
IP Rating	IP68
Hydraulics	
Total dynamic head (m)	13
Max. flow rate (m³/h)	15
External inlet diameter (mm)	40, 50, 100, 110
Discharge diameter ext. (mm)	50
Ext. ventilation diameter (mm)	50
Total volume (L)	32
Useable volume (L)	10
ON Level / OFF level (mm)	140/70
Alarm level (mm)	210
Max. temperature of the pumped liquid (5 min)	70 °C
Type of impeller	Pro X K2 grinder
Type of activation	Pneumatic
Identification and logistics	
Gross weight (kg)	23
Factory code	CUBIC1IP68NM

Sanicubic 2 Classic

Grey water, black water

Sanicubic 2 Classic is a two pump lifting station designed for the lifting of wastewater. They benefit from the Pro X K2 maceration technology lifts / discharges waste water through a small 50 mm diameter ext. pipe. The two pumps work alternately. The 5 inlets, 2 of which are low, allow great flexibility in the installation of sanitary equipment.



PERFORMANCES

- Total dynamic head : 13 m
- Max. flow rate : 15 m³/h

PRODUCT BENEFITS

- Easily accessible with removable motors and level sensors for ease of maintenance.
- Alternating operation of the 2 pumps.
- 5 inlets, 2 of which are low-level.
- Low-level switching.
- Less chance of clogging due to the Pro X K2 grinder technology.
- Discharge in 50 mm ext. pipe.



BV Cert. 6045366



DELIVERED AS STANDARD

Classic control Box



Remote wired audible and visual alarm unit (5m)



CONNECTIONS

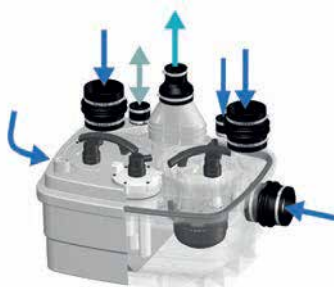

➡ External inlet diameter : 40, 50, 100, 110 mm

➡ Discharge diameter ext. : 50 mm

↔ Ext. ventilation diameter : 50 mm



Pro X K2 grinder

DIMENSIONS

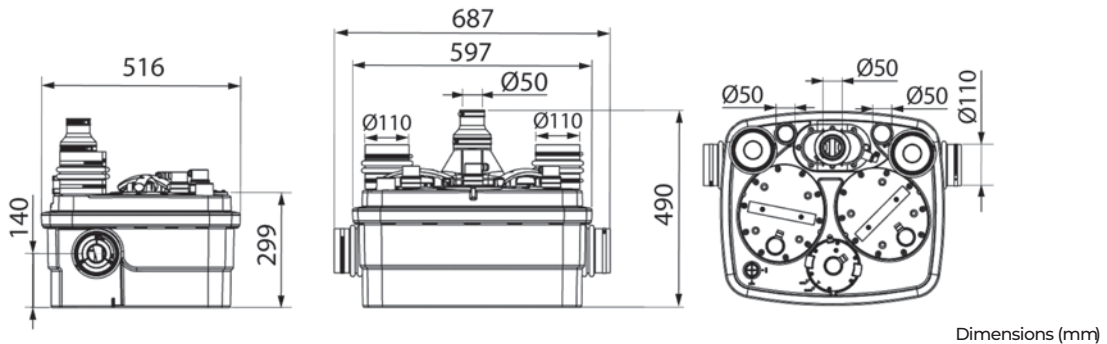

CURVE

Discharge height (m)

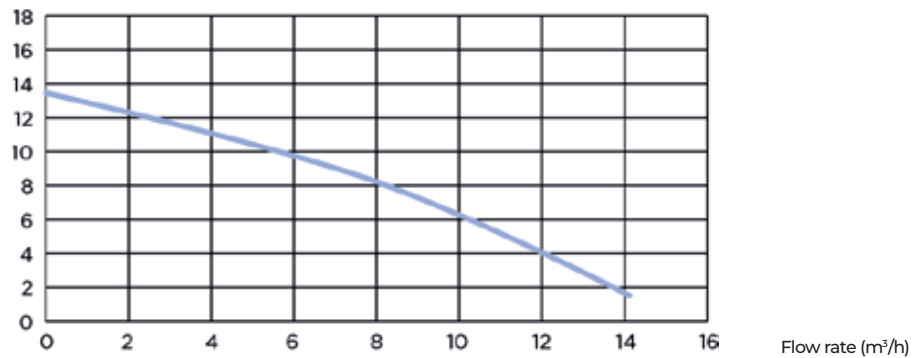

Sanicubic 2 Classic

Type of control box	Classic
Material	
Tank	PP
Pump housing	PA 12 GF
Motor housing	PA 12 GF
Impeller	PP GF
Technical features	
Voltage (V)	230
Frequency (Hz)	50-60
Power consumption P1 (W)	1500
Power output P2 (W)	1050
Mode of operation	S3 50%
IP Rating	IP68
Hydraulics	
Total dynamic head (m)	13
Max. flow rate (m ³ /h)	15
External inlet diameter (mm)	40, 50, 100, 110
Discharge diameter ext. (mm)	50
Ext. ventilation diameter (mm)	50
Total volume (L)	45
Useable volume (L)	17.5
ON Level/OFF level (mm)	140/70
Alarm level (mm)	210
Max. temperature of the pumped liquid (5 min)	70 °C
Type of impeller	Pro X K2 grinder
Type of activation	Pneumatic
Identification and logistics	
Gross weight (kg)	35
Factory code	R4LCIP68NM

Sanicubic 1 GR

Grey water, black water

Sanicubic 1 GR is a station recommended for individual use (pavilion, small commercial premises). It collects all wastewater from toilets, bathrooms, kitchens or laundry rooms. It is equipped with a pump with the Pro X K3 grinding system. It has 7 possible inlets to collect all types of waste water in the most demanding of settings.

The station is delivered with a pneumatically controlled remote control box including an audible and visual alarm.



PERFORMANCES

- Total dynamic head : 39 m
- Max. flow rate : 17 m³/h

DEPENDING ON MODEL

PRODUCT BENEFITS

- Installation without excavation.
- Accessibility in case of maintenance.
- Compact dimensions.
- 7 inlets.
- Dilution wheel.
- 5 pump versions in single or three phase.
- Integrated connection and non-return valve.

DELIVERED AS STANDARD

Control boxes ZPS - single pump version



CONNECTIONS



- Inlet diameter DN : 50, 100
- Discharge diameter DN : 50
- Ext. ventilation diameter : 75 mm



Pro X K3 grinder

DIMENSIONS

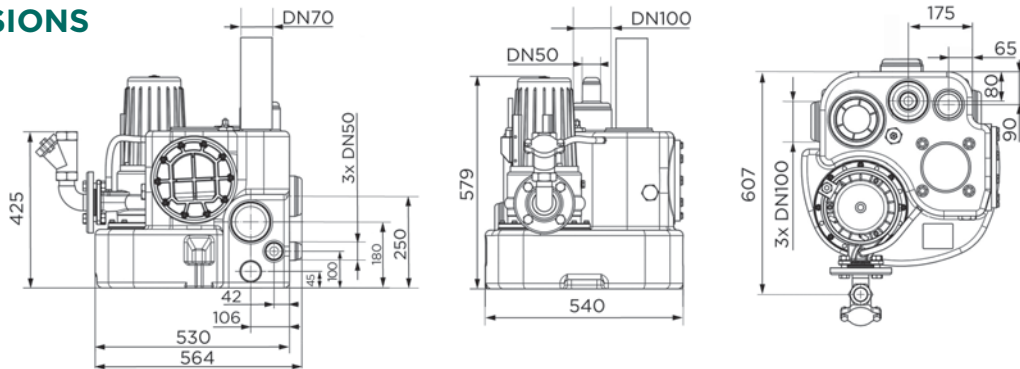

Dimensions (mm)

CURVE

Discharge height (m)

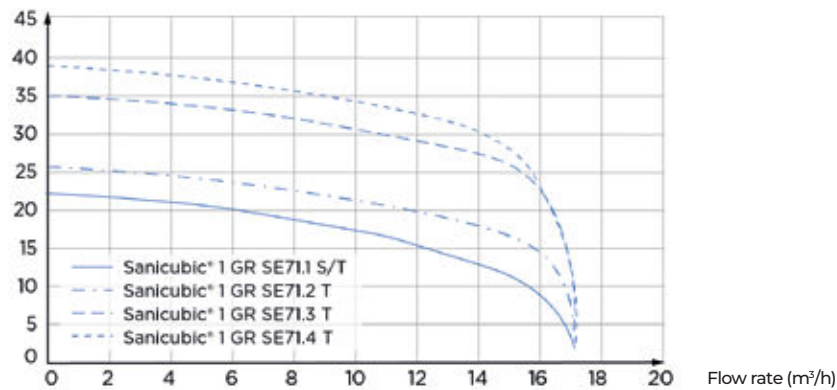

	Sanicubic 1 GR SE71.1 S	Sanicubic 1 GR SE71.1 T	Sanicubic 1 GR SE71.2 T	Sanicubic 1 GR SE71.3 T	Sanicubic 1 GR SE71.4 T
Type of control box	ZPS 1 case	ZPS 1 case	ZPS 1 case	ZPS 1 case	ZPS 1 case
Material					
Tank	PE LD	PE LD	PE LD	PE LD	PE LD
Pump housing	GG-20	GG-20	GG-20	GG-20	GG-20
Motor housing	GG-20	GG-20	GG-20	GG-20	GG-20
Impeller	GG-20	GG-20	GG-20	GG-20	GG-20
Technical features					
Voltage (V)	230	400	400	400	400
Frequency (Hz)	50-60	50-60	50-60	50-60	50-60
Power consumption P1 (W)	2200	2100	2100	3900	3900
Power output P2 (W)	1700	1700	1700	3200	3200
Mode of operation	S3 25%	S3 25%	S3 25%	S3 25%	S3 25%
IP Rating	IP68	IP68	IP68	IP68	IP68
Hydraulics					
Total dynamic head (m)	22	22	25	35	39
Max. flow rate (m ³ /h)	17	17	17	17	17
Inlet diameter DN	50, 100	50, 100	50, 100	50, 100	50, 100
Discharge diameter DN	50	50	50	50	50
Ext. ventilation diameter (mm)	75	75	75	75	75
Total volume (L)	55	55	55	55	55
ON Level /OFF level (mm)	140-250/30	140-250/30	140-250/30	140-250/30	140-250/30
Alarm level (mm)	180-290	180-290	180-290	180-290	180-290
Max. temperature of the pumped liquid (5 min)	55 °C	55 °C	55 °C	55 °C	55 °C
Type of impeller	Pro X K3 grinder	Pro X K3 grinder	Pro X K3 grinder	Pro X K3 grinder	Pro X K3 grinder
Type of activation	Pneumatic	Pneumatic	Pneumatic	Pneumatic	Pneumatic
Identification and logistics					
Gross weight (kg)	64	64	64	68	68
Factory code	CUBIC1GRSE71-1S	CUBIC1GRSE71-1T	CUBIC1GRSE71-2T	CUBIC1GRSE71-3T	CUBIC1GRSE71-4T

Sanicubic 2 GR

Grey water, black water

The Sanicubic 2 GR is a heavy duty grinder lifting station designed for villas, pool-houses etc. This station is equipped with 2 pumps with the Pro X K3 dilaceration system, which are activated simultaneously in case of a large supply.

Sanicubic 2 GR is available in 4 versions for 4 high level lifting performances. It has 5 inlets of different diameters.

The station is delivered with a pneumatically controlled remote control box including an audible and visual alarm.



PERFORMANCES

- Total dynamic head : 39 m
- Max. flow rate : 17 m³/h

DEPENDING ON MODEL

PRODUCT BENEFITS

- Installation without excavation.
- Accessibility in case of maintenance.
- Expansion wheels.
- 3 inlets DN 100, 2 inlets DN 50.
- 150 litre tank.
- 4 three-phase versions.
- Including non-return valve & outlet flange.

DELIVERED AS STANDARD

ZPS control boxes - two-pump versions



CONNECTIONS

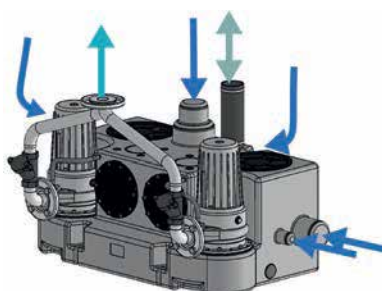

- Inlet diameter DN : 100, 150
- Discharge diameter DN : 50
- Ext. ventilation diameter : 75 mm



Pro X K3 grinder

DIMENSIONS

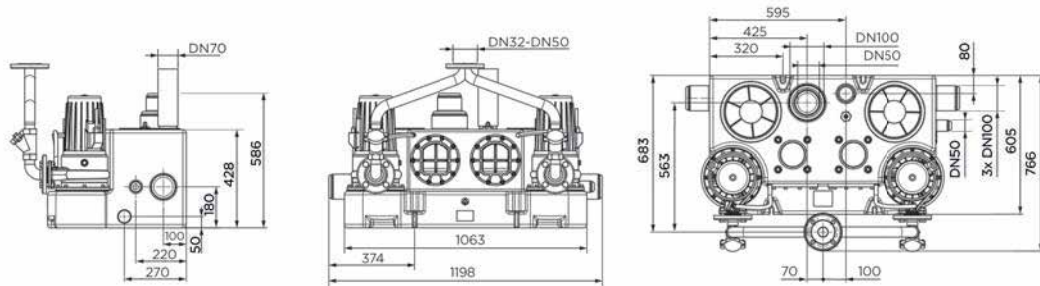

Dimensions (mm)

CURVE

Discharge height (m)

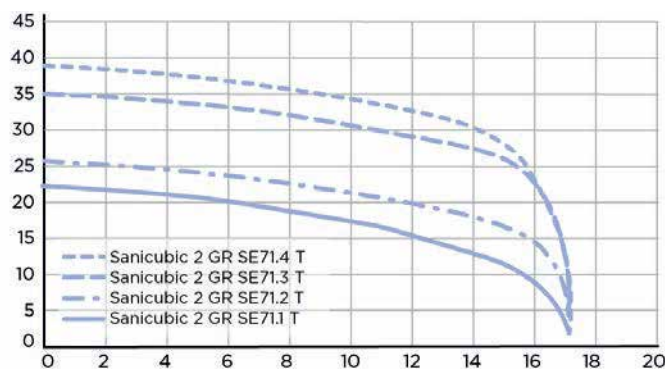

Flow rate (m³/h)

	Sanicubic 2 GR SE71.1 T	Sanicubic 2 GR SE71.2 T	Sanicubic 2 GR SE71.3 T	Sanicubic 2 GR SE71.4 T
Type of control box	ZPS 2 case	ZPS 2 case	ZPS 2 case	ZPS 2 case
Material				
Tank	PE LD	PE LD	PE LD	PE LD
Pump housing	GG-20	GG-20	GG-20	GG-20
Motor housing	GG-20	GG-20	GG-20	GG-20
Impeller	GG-20	GG-20	GG-20	GG-20
Technical features				
Voltage (V)	400	400	400	400
Frequency (Hz)	50-60	50-60	50-60	50-60
Power consumption P1 (W)	2100	2100	3900	3900
Power output P2 (W)	1700	1700	3200	3200
Mode of operation	S3 25%	S3 25%	S3 25%	S3 25%
IP Rating	IP68	IP68	IP68	IP68
Hydraulics				
Total dynamic head (m)	22	25	35	39
Max. flow rate (m ³ /h)	17	17	17	17
Inlet diameter DN	100, 150	100, 150	100, 150	100, 150
Discharge diameter DN	50	50	50	50
Ext. ventilation diameter (mm)	75	75	75	75
Total volume (L)	150	150	150	150
ON Level /OFF level (mm)	140-250/30	140-250/30	140-250/30	140-250/30
Alarm level (mm)	180-290	180-290	180-290	180-290
Max. temperature of the pumped liquid (5 min)	55 °C	55 °C	55 °C	55 °C
Type of impeller	Pro X K3 grinder	Pro X K3 grinder	Pro X K3 grinder	Pro X K3 grinder
Type of activation	Pneumatic	Pneumatic	Pneumatic	Pneumatic
Identification and logistics				
Gross weight (kg)	137	137	144	144
Factory code	CUBIC2GRSE71-1T	CUBIC2GRSE71-2T	CUBIC2GRSE71-3T	CUBIC2GRSE71-4T

Sanicubic 1 VX

Grey water, black water

Sanicubic 1 VX is 1 pump lifting station equipped with a vortex wheel. It is designed for lifting waste water from pavilions or small commercial premises. Sanicubic 1 VX has direct and secure access to the pump and level sensors. The station is delivered with a remote control box and an audible and visual alarm.



PERFORMANCES

- Total dynamic head : 13 m
- Max. flow rate : 40 m³/h

PRODUCT BENEFITS

- Installation without excavation.
- Accessibility in case of maintenance.
- 3 inlets.
- Vortex wheel.
- Direct and safe access to the pump.
- Including remote control panel.
- Including wired alarm.



BV Cert. 6045366



DELIVERED AS STANDARD

Classic control Box



Remote wired audible and visual alarm unit (5m)



CONNECTIONS

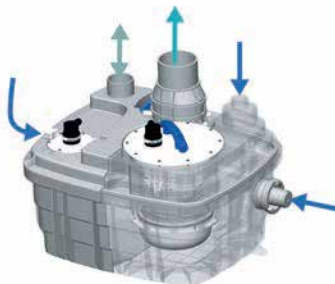

External inlet diameter : 40, 50, 100, 110, 125 mm

Discharge diameter ext. : 90/110 mm

Ext. ventilation diameter : 75 mm



Impeller vortex

DIMENSIONS

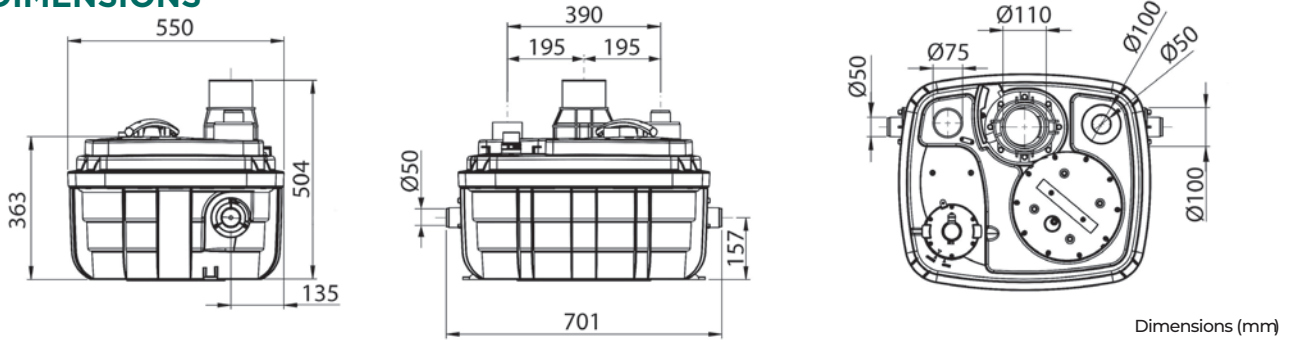

Dimensions (mm)

CURVE

Discharge height (m)

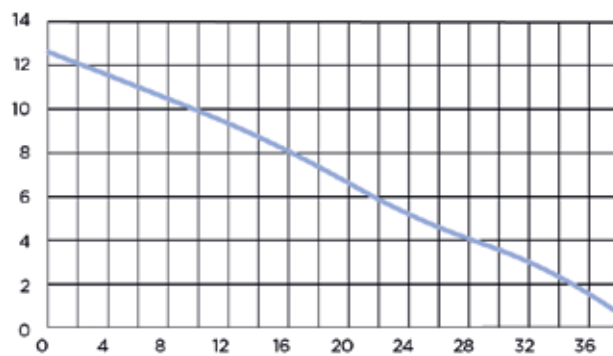

Flow rate (m³/h)

Sanicubic 1 VX

Type of control box	Classic
Material	
Tank	PP GF
Pump housing	PA 12 GF
Motor housing	PA 12 GF
Impeller	PPO GF
Technical features	
Voltage (V)	230
Frequency (Hz)	50-60
Power consumption P1 (W)	2000
Power output P2 (W)	1400
Mode of operation	S3 15%
IP Rating	IP68
Hydraulics	
Total dynamic head (m)	13
Max. flow rate (m ³ /h)	40
External inlet diameter (mm)	40, 50, 100, 110, 125
Discharge diameter ext. (mm)	90/110
Ext. ventilation diameter (mm)	75
Total volume (L)	60
Useable volume (L)	21
ON Level /OFF level (mm)	165/95
Alarm level (mm)	235
Particle size (mm)	50
Max. temperature of the pumped liquid (5 min)	70 °C
Type of impeller	Vortex
Type of activation	Pneumatic
Identification and logistics	
Gross weight (kg)	30
Factory code	CUBIC1XLVX

Sanicubic 2 VX

Grey water, black water

The Sanicubic 2 VX lifting station is designed for lifting waste water from shops, private homes and public facilities. It is equipped with two pumps with a vortex impeller leaving a free passage of 50 mm. The 5 inlets of the device allow the connection of several sanitary equipment.



PERFORMANCES

- Total dynamic head : 16 m
- Max. flow rate : 55 m³/h

PRODUCT BENEFITS

- Installation without digging / excavation.
- Accessibility in case of maintenance.
- 5 inputs, 2 of which are low.
- Low engagement.
- 2 vortex impellers.
- Alternating motor operation.



BY Cert. 60H5366



DELIVERED AS STANDARD

Classic control Box



Remote wired audible and visual alarm unit (5m)



CONNECTIONS



External inlet diameter : 40, 50, 100, 110, 125 mm

Discharge diameter ext. : 90/110 mm

Ext. ventilation diameter : 75 mm



Vortex

DIMENSIONS

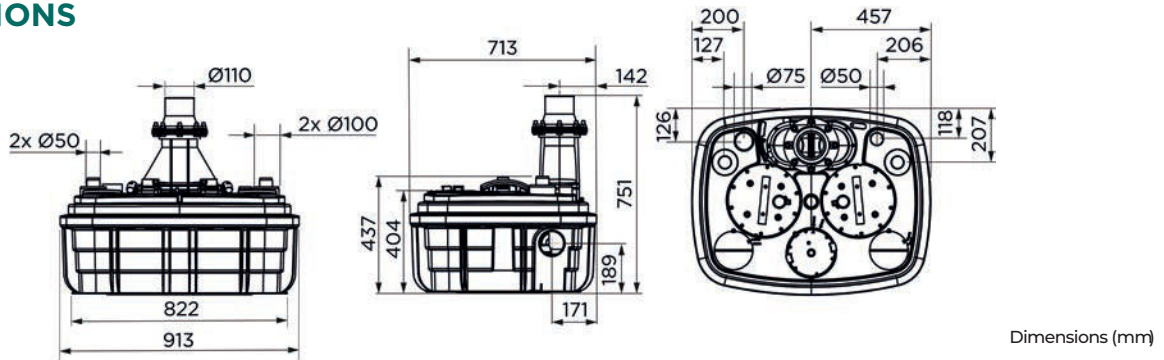

CURVE

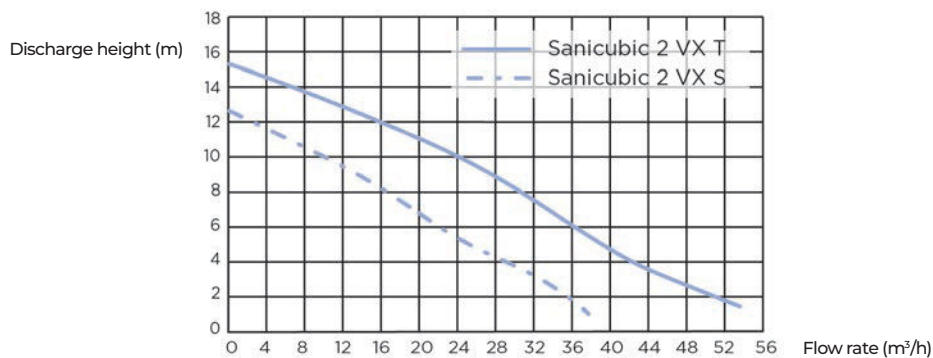

	Sanicubic 2 VX S	Sanicubic 2 VX T
Type of control box	Classic	Classic
Material		
Tank	PP GF	PP GF
Pump housing	PA 12 GF	PA 12 GF
Motor housing	PA 12 GF	PA 12 GF
Impeller	PPO GF	PPA GF
Technical features		
Voltage (V)	230	400
Frequency (Hz)	50-60	50-60
Power consumption P1 (W)	2000	3500
Power output P2 (W)	1400	2800
Mode of operation	S3 30%	S3 15 %
IP Rating	IP68	IP68
Hydraulics		
Total dynamic head (m)	13	16
Max. flow rate (m³/h)	40	55
External inlet diameter (mm)	40, 50, 100, 110, 125	40, 50, 100, 110, 125
Discharge diameter ext. (mm)	90/110	90/110
Ext. ventilation diameter (mm)	75	75
Total volume (L)	120	120
Useable volume (L)	26	26
ON Level /OFF level (mm)	165/95	165/95
Alarm level (mm)	235	235
Particle size (mm)	50	50
Max. temperature of the pumped liquid (5 min)	70 °C	70 °C
Type of impeller	Vortex	Roue vortex
Type of activation	Pneumatic	Pneumatic
Identification and logistics		
Gross weight (kg)	101	102
Factory code	CUBIC2XLVX	CUBIC2XLVXTRI

Sanicubic 1 SC

Grey water, black water

Sanicubic 1 SC is a lifting station with 1 three-phase cast iron pump with a single-channel impeller. Designed for lifting waste water from public buildings or shopping centres, this station is available in 4 versions. It is delivered with a pneumatic remote control box including an audible and visual alarm.



PERFORMANCES

- Total dynamic head : 22 m
- Max. flow rate : 165 m³/h

DEPENDING ON MODEL

PRODUCT BENEFITS

- Installation without excavation.
- Accessibility in case of maintenance.
- 1 inlet DN150.
- 3-phase cast iron pump.
- Free passage 80 mm or 100 mm.
- Control panel included (ZPS or PS2).
- Star-delta start for Sanicubic 1 SC7.5T.
- Customisation possible (tank volume and inlets) for tailor-made installation.

DELIVERED AS STANDARD

Control boxes ZPS - single pump version



PS2 system box



CONNECTIONS

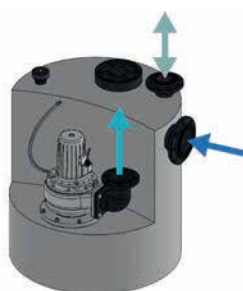

- Inlet diameter DN : 150
- Discharge diameter DN : 100
- Ventilation diameter DN : 100



Single-channel

DIMENSIONS

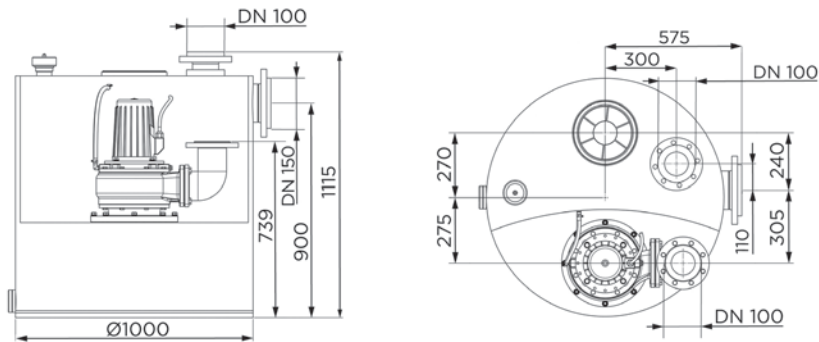

Dimensions (mm)

CURVE

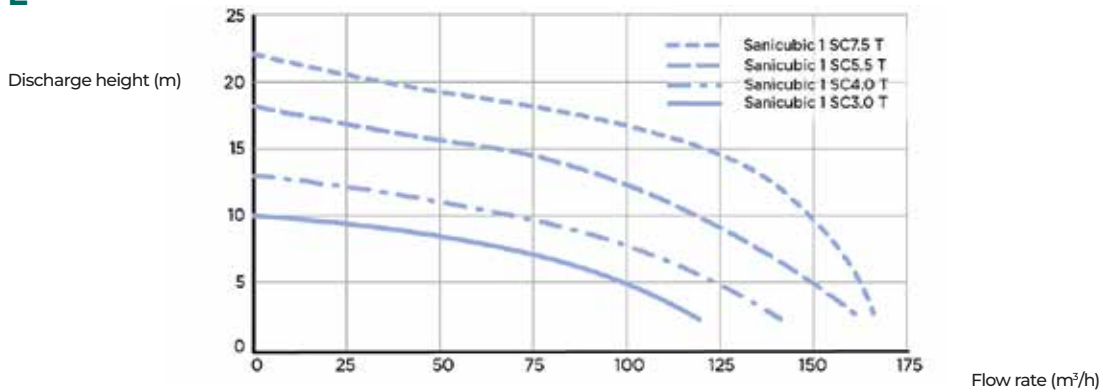

	Sanicubic 1 SC3.0 T	Sanicubic 1 SC4.0 T	Sanicubic 1 SC5.5 T	Sanicubic 1 SC7.5 T
Type of control box	ZPS 1 case	ZPS 1 case	ZPS 1 case	PS2 system box
Material				
Tank	PE HD	PE HD	PE HD	PE HD
Pump housing	GG-20	GG-20	GG-20	GG-20
Motor housing	GG-20	GG-20	GG-20	GG-20
Impeller	GG-20	GG-20	GG-20	GG-20
Technical features				
Voltage (V)	400	400	400	400
Frequency (Hz)	50-60	50-60	50-60	50-60
Power consumption P1 (W)	4000	5500	6300	8700
Power output P2 (W)	3000	4000	5500	7500
Mode of operation	S3 25%	S3 25%	S3 25%	S3 25%
IP Rating	IP68	IP68	IP68	IP68
Hydraulics				
Total dynamic head (m)	10	13	18	22
Max. flow rate (m³/h)	120	140	160	165
Inlet diameter DN	150	150	150	150
Discharge diameter DN	100	100	100	100
Ventilation diameter DN	100	100	100	100
Total volume (L)	480	480	480	480
Useable volume (L)	270	270	270	270
Particle size (mm)	80	80	100	100
Max. temperature of the pumped liquid (5 min)	55 °C	55 °C	55 °C	55 °C
Type of impeller	Single-channel	Single-channel	Single-channel	Single-channel
Type of activation	Pneumatic	Pneumatic	Pneumatic	Pneumatic
Identification and logistics				
Gross weight (kg)	210	220	225	240
Factory code	CUBIC1SC3-0T	CUBIC1SC4-0T	CUBIC1SC5-5T	CUBIC1SC7-5T

Sanicubic 2 SC

Grey water, black water

Sanicubic 2 SC is a floor-mounting lifting station with 2 single-channel impeller pumps. Sanicubic 2 SC is available in 4 versions. It has a DN 150 inlet for lifting large volumes of waste water from public buildings or blocks of flats.

It is delivered with a pneumatically controlled remote control box (ZPS) including an audible and visual alarm. The Sanicubic 2 SC7.5T version is supplied with a PS2 control box integrated in an electrical cabinet.



PERFORMANCES

- Total dynamic head : 22 m
- Max. flow rate : 165 m³/h

DEPENDING ON MODEL

PRODUCT BENEFITS

- Two three-phase pumps.
- 1 inlet DN150.
- 4 versions available.
- 1000 litre tank.
- Free passage 80 mm or 100 mm.
- Control panel included (ZPS or PS2).
- Star-delta start for the Sanicubic 2 SC7. 5T.
- Tank customisation on request (tank volume up to 20000 L and number of inlets).
- Optional mounting accessories available.

DELIVERED AS STANDARD

ZPS control boxes - two-pump versions



PS2 system box



CONNECTIONS

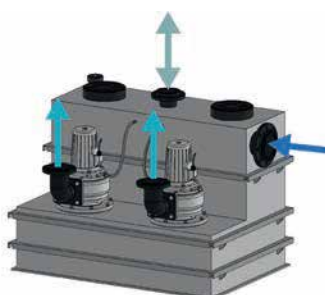

- Inlet diameter DN : 150
- Discharge diameter DN : 100
- Ventilation diameter DN : 100



Single-channel

DIMENSIONS

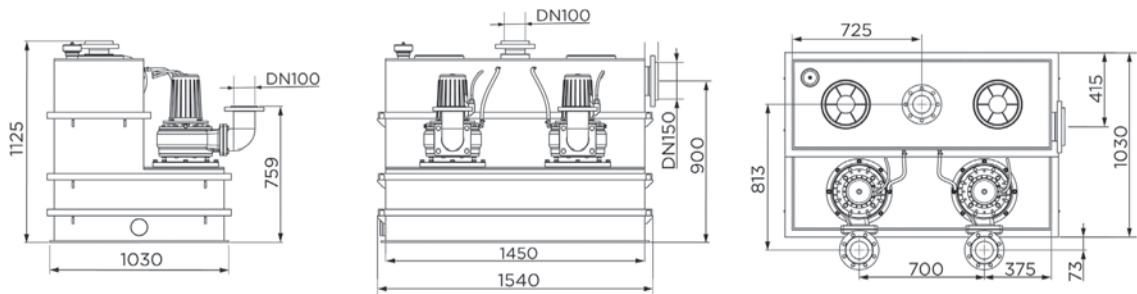

Dimensions (mm)

CURVE

Discharge height (m)

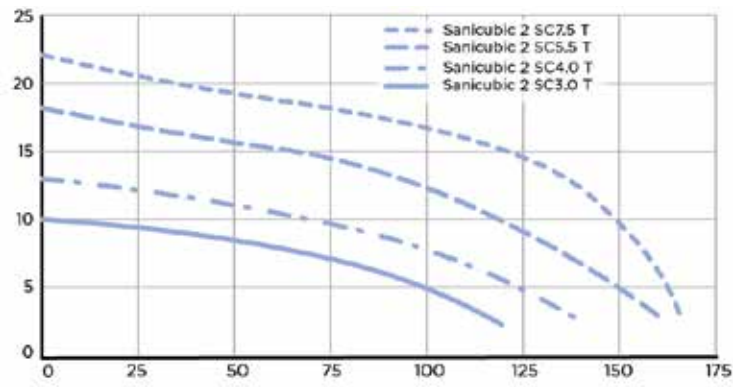

Flow rate (m³/h)

	Sanicubic 2 SC3.0 T	Sanicubic 2 SC4.0 T	Sanicubic 2 SC5.5 T	Sanicubic 2 SC7.5 T
Type of control box	ZPS 2 case	ZPS 2 case	ZPS 2 case	PS2 system box
Material				
Tank	PE HD	PE HD	PE HD	PE HD
Pump housing	GG-20	GG-20	GG-20	GG-20
Motor housing	GG-20	GG-20	GG-20	GG-20
Impeller	GG-20	GG-20	GG-20	GG-20
Technical features				
Voltage (V)	400	400	400	400
Frequency (Hz)	50-60	50-60	50-60	50-60
Power consumption P1 (W)	4000	5500	6300	8700
Power output P2 (W)	3000	4000	5500	7500
Mode of operation	S3 25%	S3 25%	S3 25%	S3 25%
IP Rating	IP68	IP68	IP68	IP68
Hydraulics				
Total dynamic head (m)	10	13	18	22
Max. flow rate (m ³ /h)	120	140	160	165
Inlet diameter DN	150	150	150	150
Discharge diameter DN	100	100	100	100
Ventilation diameter DN	100	100	100	100
Total volume (L)	1000	1000	1000	1000
Useable volume (L)	500	500	500	500
Particle size (mm)	80	80	100	100
Max. temperature of the pumped liquid (5 min)	55 °C	55 °C	55 °C	55 °C
Type of impeller	Single-channel	Single-channel	Single-channel	Single-channel
Type of activation	Pneumatic	Pneumatic	Pneumatic	Pneumatic
Identification and logistics				
Gross weight (kg)	370	385	400	425
Factory code	CUBIC2SC3-0T	CUBIC2SC4-0T	CUBIC2SC5-5T	CUBIC2SC7-5T

Accessories and control boxes

Alarm units

Wired audible and visual alarm unit

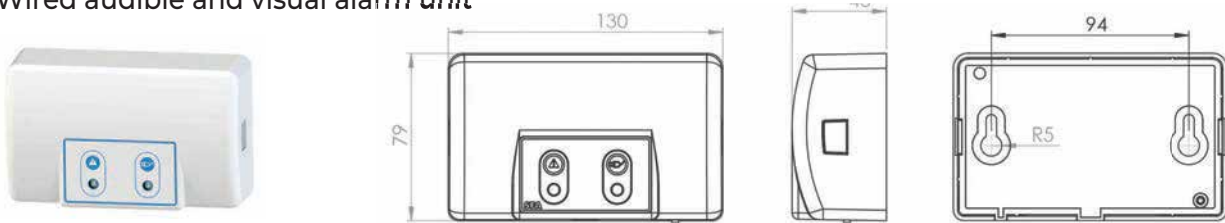

The Sanicom 1 alarm is a 5 m long wired alarm allowing you to monitor your sanicom 1 or 2 from another room. This alarm is powered by the station and therefore does not require an independent power supply. In case of power failure, the battery of the alarm box takes over. The alarm box can detect an abnormal water level in the tank and monitor the power supply.

- IP Rating IP44
- 5m cable

Product	Factory code	To be used with	
Wired alarm box Sanicom 1	BOITALARMCOM1002	Sanicom 1	optional
Remote wired audible and visual alarm unit (5m)	BOITALARMCOM2002	Sanicom 2	optional
Remote wired audible and visual alarm unit (5m)	-	Sanicubic 1 WP/1 VX/2 Classic/2VX	delivered as standard

Control Boxes

Remote control unit (4 m cable)

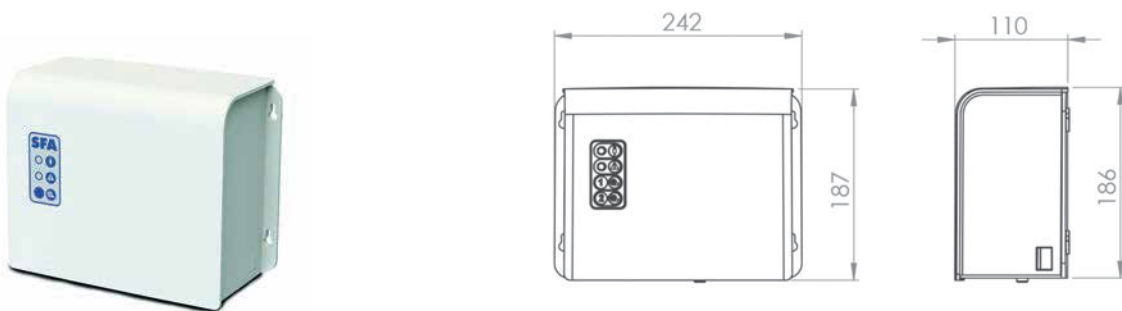

The control box is delivered with a 4 m cable allowing its remote installation. It allows the monitoring of your station with the possibility of activating the forced operation. A visual and sound alarm is triggered in case of abnormally high water level in the tank or in case of power failure.

Product	Factory code	To be used with	
Classic control Box	-	Sanicom 2 Sanicubic 1 WP Sanicubic 1 VX Sanicubic 2 Classic Sanicubic 2 VX	delivered as standard

ZPS Control box



ZPS 1 Control Box



ZPS 2 Control Box

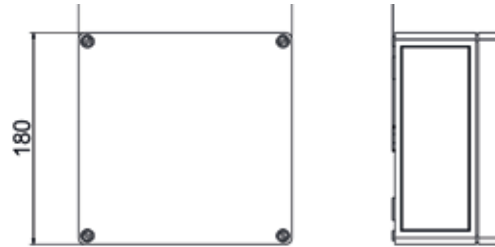

The ZPS control panels are available in 4 models: version for 1 or 2 pumps, single or three-phase, with pneumatic or float control. Integrated acoustic and visual alarm. Display of the operating status of the pump(s) by text messages and indicator light. Internal memory for up to 64 messages. Automatic operation with a single pump, and alternating operation with two-pump stations, with the second pump being activated when required. Level control possible by dynamic pressure. Float switch or 4-20 mA interface for external sensor. Display of operating hours, power consumption and maintenance intervals. Wall mounting provided.

Product	Factory code	To be used with
CONTROL BOX ZPS 1 S PNEUMATIC	ZPS-001	Sanicubic 1 GR/SC
CONTROL BOX ZPS 2 S PNEUMATIC	ZPS-002	Sanicubic 2 GR/SC
CONTROL BOX ZPS 1 T PNEUMATIC	ZPS-003	Sanicubic 1 GR/SC
CONTROL BOX ZPS 2 T PNEUMATIC	ZPS-004	Sanicubic 2 GR/SC
CONTROL BOX ZPS 1 S FLOAT	ZPS-005	Sanicubic 1 GR/SC
CONTROL BOX ZPS 2 S FLOAT	ZPS-006	Sanicubic 2 GR/SC
CONTROL BOX ZPS 1 T FLOAT	ZPS-007	Sanicubic 1 GR/SC
CONTROL BOX ZPS 2 T FLOAT	ZPS-008	Sanicubic 2 GR/SC

PS2 System Box



- The PS2 system case is built into the control cabinet door and a control unit clipped onto the rail.
- Possible to connect different level sensors.
- Complete control of pump operation via LCD display and digital potentiometer.
- 8 LEDs indicate pump status and faults.
- Dimensions: W 600 x H 600 x D 210

Product	Factory code	To be used with	
PS2 system box	-	Sanicubic SC7.5T	delivered as standard

WHY SANICLIM?

Air conditioners generate condensate, which may need to be removed to drain them discreetly.

To meet this need, SFA offers solutions to remove condensates from air conditioners with a cooling capacity of up to 8 kW.

Ensure that the pump is suitable for your air conditioner:

It is generally accepted that the volume of condensate water to be drained is approximately 0.5 to 0.8 L/hr per kW of cooling capacity (this value can increase sharply in areas with very high humidity). This means that for a 5 kW air conditioner, for example, the volume of condensates to be drained will be 2.5 to 4 L/h.

To carry out a functional installation adapted to your air conditioner, it is important to consider the discharge losses: the suction height, the vertical delivery height and finally the horizontal discharge length.

WHY SANICONDENS?

Gravity drainage for boiler condensates is not always possible.











This is why SFA provides a condensate lifting pump: for gas and oil boilers, for small kitchen boilers as well as for large capacity boilers (up to 50 kW).

Condensates emitted by combustion appliances have a very low pH value (acid).

To avoid damaging the drainage system, it is recommended to neutralize those condensates.

Condensate pump for air conditioners and boilers



	 GAS boiler	 OIL boiler	 Air conditioner	 Refrigerated display	 Dehumidifier	 Air conditioning box
 <p>Sanicondens Clim mini S Extremely compact design for a completely discreet installation</p> <p>P.48</p>			•			
 <p>Sanicondens Clim Pack S Aesthetic installation Easy installation Reversible plate</p> <p>P.49</p>			•			
 <p>Sanicondens Clim Deco Compact solution Easy installation</p> <p>P.50</p>			•			
 <p>Sanicondens Pro All accessories as standard and an alarm pre-connection</p> <p>P.51</p>	MAXIMUM 50 kW	MAXIMUM 30 kW	•	•	•	•

- DISCREET INSTALLATION THANKS TO ITS COMPACT SIZE
- A SILENT RANGE FOR QUIET OPERATION
- PUMPING PERFORMANCE: UP TO 6 M
- EASY ASSEMBLY THANKS TO THE FIXING KIT SUPPLIED
- SEVERAL INLETS AVAILABLE FOR GREATER FLEXIBILITY OF INSTALLATION (Sanicondens Pro)



Sanicondens Clim Mini S

Specifically designed to lift or discharge the condensate from air conditioning units.

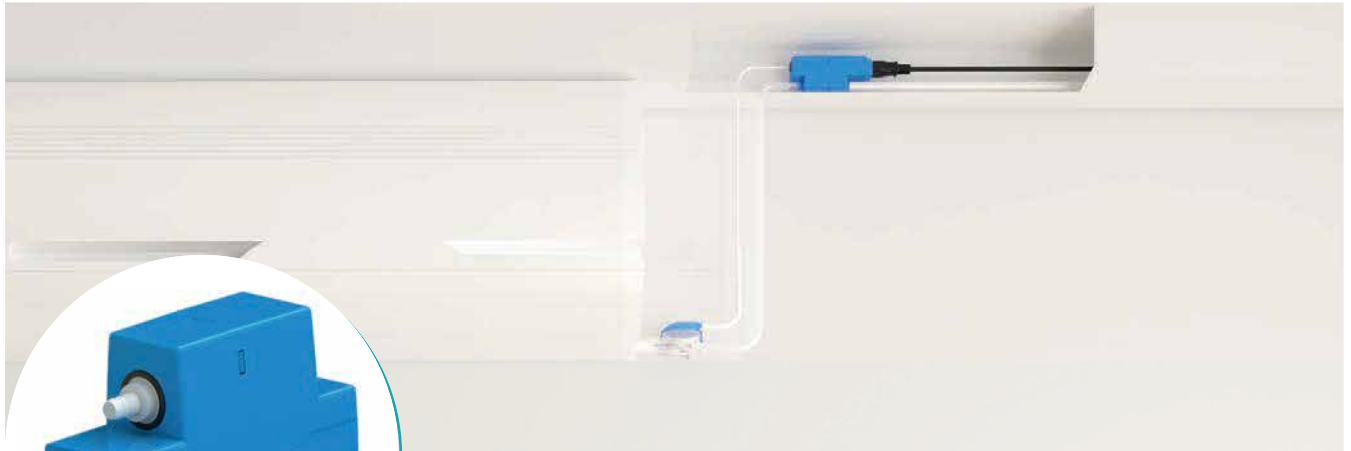

6 m
↑



PRODUCT BENEFITS

- Compact solution for discreet installation.
- Silent: only 21 dB(A).
- Safety system: 130 °C thermal protector and overflow alarm.
- Easy to check: transparent base.

CONNECTIONS

- (A) elbow adaptor
- (B) level sensor
- (C) pump unit
- (D) anti-siphoning vacuum breaker
- (E) waste water pipe

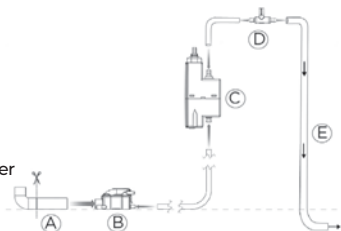

TECHNICAL FEATURES

Max. power of the air conditioning unit	8 kW
Inlet diameter DN	16 mm
Discharge diameter DN	6 mm
Max. flow rate	9 l/h +/-15%
Max. incoming temperature	35 °C
Max. suction distance between the detection bloc and the pump	2 m
Voltage - Frequency	220-240 V - 50-60 Hz
Max. power consumption	22 W
IP Rating	IP24
Noise level	21 dB(A)
Identification and logistics	
Factory code	CLIMMINI3S

PACKAGING

Sanicondens Clim mini pump, detection unit, 1.2 m flexible hose, mounting bracket, vent tube, power cable supplied

CURVE

Discharge height (m)

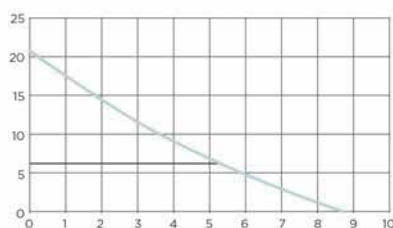

Flow rate (l/h)

DIMENSIONS

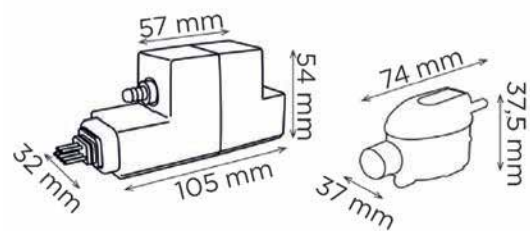

Dimensions (mm)

Sanicondens Clim Pack S



Complete solution for neat installation.



6 m



PRODUCT BENEFITS

- Complete solution for aesthetic installation
- Easy installation: fixing and connection accessories included
- Reversible plate: right or left

CONNECTIONS

- (A) elbow adaptor
- (B) level sensor
- (C) pump unit
- (D) anti-siphoning vacuum
- (E) waste water pipe

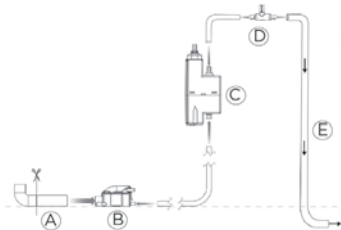

TECHNICAL FEATURES

Max. power of the air conditioning unit	8 kW
Inlet diameter DN	16 mm
Discharge diameter DN	6 mm
Max. flow rate	9 L/h +/- 15 %
Max. incoming temperature	35 °C
Max. suction distance between the detection bloc and the pump	2 m
Voltage - Frequency	220-240 V - 50-60 Hz
Max. power consumption	22 W
IP Rating	IP24
Noise level	21 dB(A)
Identification and logistics	
EAN code	3308815083919
Factory code	CLIMPACK3SBL

PACKAGING

Sanicondens Clim pack pump, detection unit, trunking, 1.2 m flexible hose, mounting bracket, vent tube, power cable supplied

CURVE

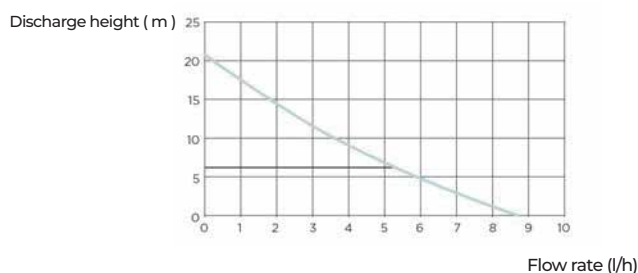

DIMENSIONS

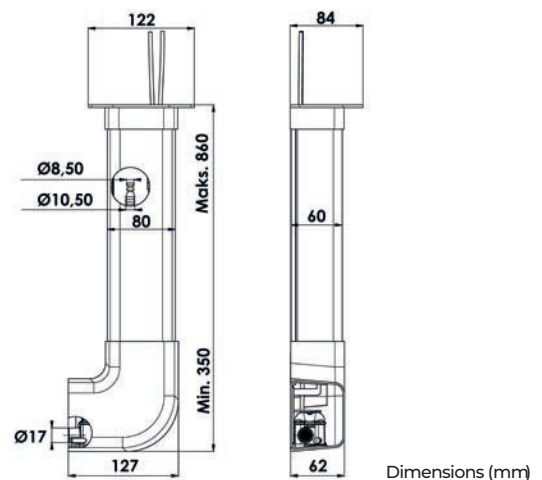



Sanicondens Clim Deco

Compact solution and easy installation.



6 m



PRODUCT BENEFITS

- Compact solution for aesthetic installation
- Easy installation: fixing kit supplied
- Automatically reset thermal protector

CONNECTIONS

← Discharge diameter DN : 8-10 mm

→ Inlet diameter DN : 22 mm



PACKAGING

Sanicondens Clim Deco, wall mounting, cover screws

CURVE

Discharge height (m)

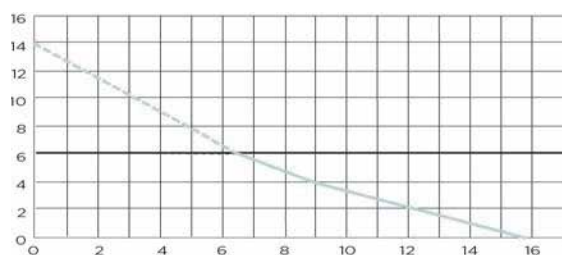

Flow rate (l/h)

TECHNICAL FEATURES

Max. power of the air conditioning unit	10 kW
Number of entries	1
Inlet diameter DN	22 mm
Discharge diameter DN	8-10 mm
Tank volume	0.175 L
Max. flow rate	15 L/h
Max. incoming temperature	35 °C
Voltage - Frequency	220-240 V - 50-60 Hz
Max. power consumption	22 W
Electrical class	II
IP Rating	IP24
Noise level	23 dB(A)
Identification and logistics	
Gross weight	0.9 kg
EAN code	3308815012216
Factory code	CLIMDECO2

DIMENSIONS

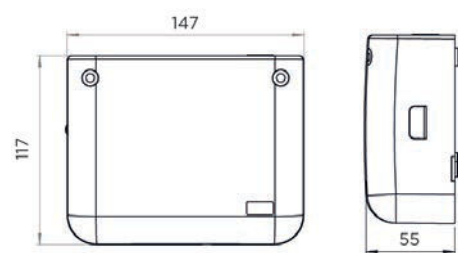

Dimensions (mm)



Sanicondens Pro

Specifically designed to lift condensate from boilers but also AC systems.



4.5 m
50 m



BV Cert. 0943364



PRODUCT BENEFITS

- Compact and silent solution.
- Connections possible with gas and oil boilers, floor and wall mounted units, refrigerated display cabinets,.
- Air conditioners, air conditioning cassettes and dehumidifiers.
- Alarm pre-connection.
- Easy installation: complete kit included.

CONNECTIONS

- ← Discharge diameter (int.) : 10 mm
- Inlet diameter DN : 28 mm

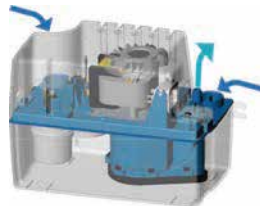

PACKAGING

Sanicondens Pro, non-return valve included, fixing screw, 1 inlet adapter, 1 outlet adapter (Ø 50 mm), 1 drain hose 5 m, 1 power cable 1.5 m, 1 rubber stopper, 1 alarm pre-connection cable

CURVE

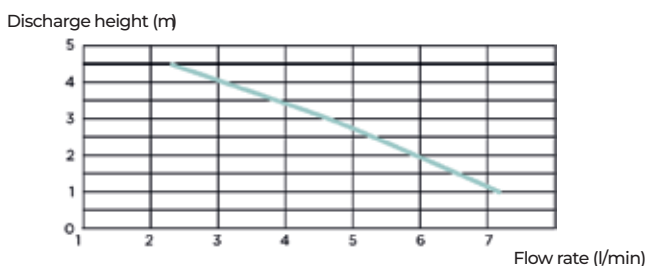

TECHNICAL FEATURES

Max. power of the boiler	Oil 30, Gas 50 kW
Number of entries	2
Inlet diameter DN	28 mm
Discharge diameter (int.)	10 mm
Tank volume	2.2 L
Max. incoming temperature	80 °C (S3 15%)
Voltage - Frequency	220-240 V - 50-60 Hz
Max. power consumption	60 W
Maximum current	0.52 A
Electrical class	I
IP Rating	IP24
Noise level	< 45 dB(A)
Alarm pre-connection	yes
Identification and logistics	
Gross weight	3 kg
Factory code	SK6

DIMENSIONS

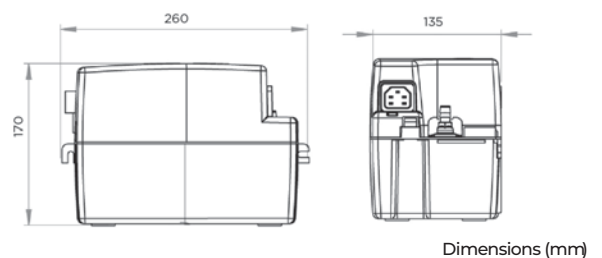



Web: <https://iwsind.in/sfa-france-powerful-pumps/>

SALES: Chief Sales Officer - iwschiefsalesofficer@gmail.com or
phone:9346210707

SERVICE: Customer Relationship Manager - iwscrmsales@gmail.com or
phone:8099935794

Suppliers: KiTECinnovative@gmail.com

Careers: iwscareers@gmail.com

